



# **EO<sup>®</sup> Ermeto Original** ***Rotary fittings***



Visual index EO rotary fittings

**DG 101**  
p. Q6

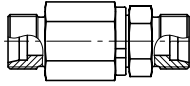

EO 24° cone end /  
EO 24° cone end

**DG 102-R**  
p. Q7

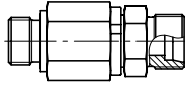

Male BSPP thread –  
ED-seal (ISO 1179) / EO 24° cone end

**DG 102-M**  
p. Q8

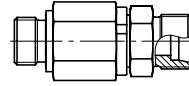

Male metric thread –  
ED-seal (ISO 1179) / EO 24° cone end

**DG 103**  
p. Q9

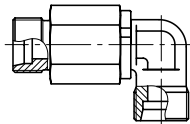

EO 24° cone end /  
EO 24° cone end

**DG 104-R**  
p. Q10

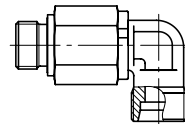

Male BSPP thread –  
ED-seal (ISO 1179) / EO 24° cone end

**DG 104-M**  
p. Q11

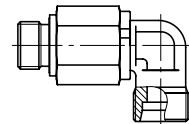

Male metric thread –  
ED-seal (ISO 1179) / EO 24° cone end

**DG 105**  
p. Q12

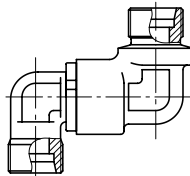

EO 24° cone end /  
EO 24° cone end

**DG 106-R**  
p. Q13

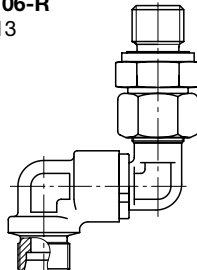

Male BSPP thread –  
ED-seal (ISO 1179) / EO 24° cone end

**DG 106-M**  
p. Q14

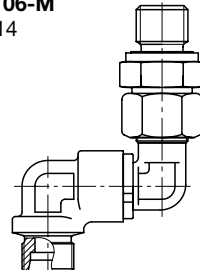

Male metric thread –  
ED-seal (ISO 1179) / EO 24° cone end

**DG 107**  
p. Q15

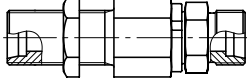

EO 24° cone end /  
EO 24° cone end

**DG 108**  
p. Q16

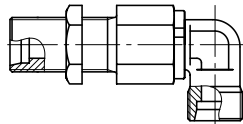

EO 24° cone end /  
EO 24° cone end

**DG 208**  
p. Q17

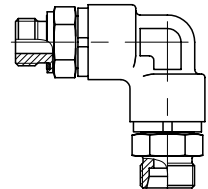

Male BSPP thread –  
ED-seal (ISO 1179) / EO 24° cone end

**DVGE-R**  
p. Q18

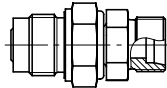

Male BSPP thread –  
ED-seal / EO 24° cone end

**DVGE-M**  
p. Q19

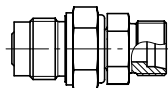

Male metric thread –  
ED-seal / EO 24° cone end

**DVWE-R**  
p. Q20

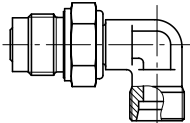

Male BSPP thread –  
ED-seal / EO 24° cone end

**DVWE-M**  
p. Q21

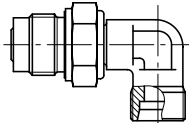

Male metric thread –  
ED-seal / EO 24° cone end

## DG Ball bearing rotary fittings

For working pressures up to 350 bar.  
Favourable pressure/RPM ratio

### Application:

Connecting a fixed point to a rotating, swinging or moving machine part via hoses.  
To prevent torsion and to avoid small hose radius.

### Flow media:

Hydraulic oils and lubricants on mineral oil base.  
Also for hydraulic fluids HETG and HEES.  
Not suitable for corrosive and HFC-fluids or gases.

### Construction:

Compact, maintenance-free construction, service-proved. Combined ball and plain bearing with constant lubrication. Low starting torque. Wear-resistant annular piston sealings.

### Materials:

Casing, body nut of steel, annular piston sealing: POM (e. g. Delrin)/FKM. Eolastic sealing: NBR (e.g. Perbunan), also available in FKM.

### Surface:

Cr(VI)-free.

### Nominal temperatures:

-14° C up to +80°C.

### Warehousing:

Ball bearing rotary fittings can be stocked for 6 months. Warehousing up to 1 year is possible with storage conditions acc. to DIN 7716.

Perbunan = registered trademark of Bayer

### Construction systems:

8 different versions with one rotational axis. Multiaxial rotary couplings on request. Tube connections according to DIN 2353, series S.  
Maximum working pressure 350 bar (peak pressure)  
Male stud sealing by Eolastic seals of NBR.  
Male stud with metric parallel or BSPP thread.

### Assembly instructions:

The life of a rotary fitting depends considerably on a stress-free line connection. Therefore the direct connection with tubes is to be avoided.  
For connection of hoses the use of swivel nut fittings (DIN 3865) is recommended.  
We recommend short, straight hose lines (free hose length approx. 5× hose O.D.). Thus shocks, vibrations etc. are absorbed.

### Attention!

Maximum permissible flowrate of media: 5 m/s (see page C13.)

## Number of revolutions and starting torques:

Chart 1

Tube O.D.	DN Nominal diameter (mm)	Permissible number of revolutions (rpm.) under a working pressure of						Initial torque at 250 bar/Nm
		25 bar	64 bar	100 bar	160 bar	250 bar	350 bar	
6 8	5.0	1500	750	400	200	85	85	0.08
12 16	9.5	800	400	200	100	45	45	0.24
20 25	16.0	300	150	75	38	15	15	0.8
30 38	26.0	200	100	50	25	10	10	2.0



DG Ball bearing rotary fittings

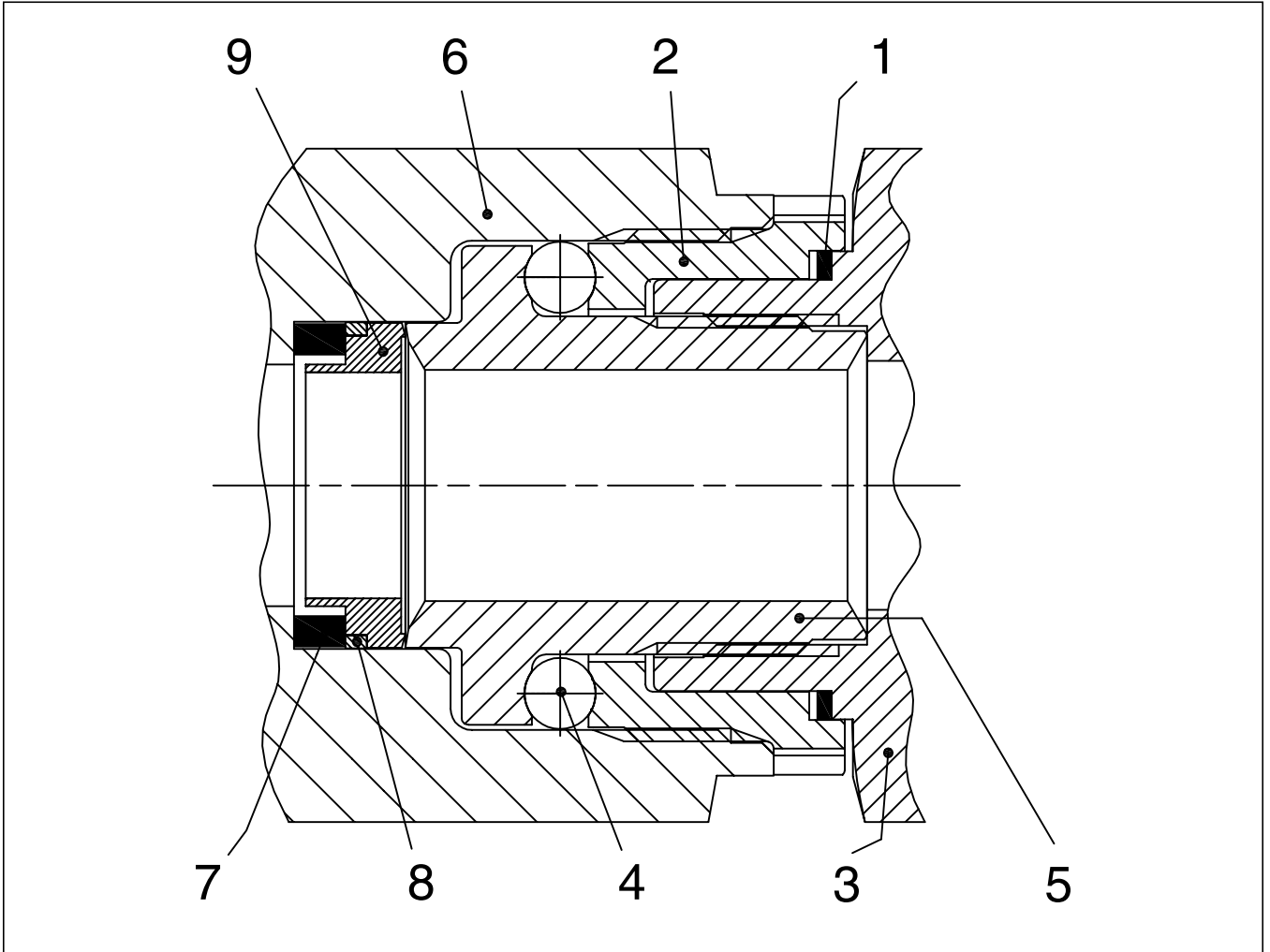

9	ring piston
8	intermediate ring
7	rubber spring
6	base
5	pivot
4	ball
3	top
2	raceway
1	dust seal
position	specification

## Plain bearing rotary fittings

for slow rotating, swinging or moving machine parts up to 40 bar (series L) or up to 100 bar (series S).

### Application:

Connecting a fixed point to a rotating, swinging or moving machine part via hoses.  
To prevent torsion and to avoid small hose radius.

### Flow media:

Hydraulic oils and lubricants on mineral oil base.  
Also for hydraulic fluids HETG and HEES.  
Not suitable for corrosive and HFC-fluids or gases.

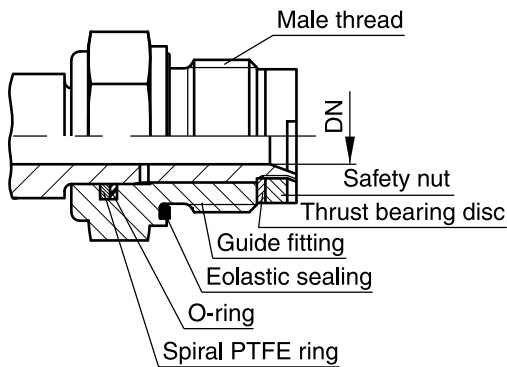

### Nominal temperature:

For sealings of NBR:  
-35° C up to +100° C.  
For sealings of FKM:  
-25° C up to +120° C.

Tube O.D.		DN Nominal diameter mm
06L	06S	<b>4</b>
08L	08S	<b>5</b>
10L	10S	<b>6</b>
12L	12S	<b>8</b>
15L	14S 16S	<b>10</b>
18L 22L	20S 25S	<b>16</b>
28L	30S	<b>22</b>
35L	43L 38S	<b>25</b>

### Construction:

Compact, maintenance-free construction, service-proved.

### Materials:

Casing, body nut and progressive ring of steel. Sealing of NBR (Perbunan), on request of FKM.  
Plain bearing rotary fittings are not available in stainless steel or brass.

### Surface:

Cr(VI)-free.

### Construction-system:

Series L, tube O. D. 6 to 35 mm, working pressure (PN): 40 bar  
Series S, tube O. D. 6 to 38 mm, working pressure (PN): 100 bar  
Tube connection according to DIN 2353, ISO 8434-1.  
Male stud with metric thread and BSP thread.  
Sealing of male stud by Eolastic-seals.

Perbunan = registered trademark of Bayer

### Number of revolutions:

Series	L									
Tube O.D.	6	8	10	12	15	18	22	28	35	
Permiss. no. rpm	28	28	21	17	13	10	10	7	7	
Series	S									
Tube O.D.	6	8	10	12	14	16	20	25	30	38
Permiss. no rpm	11	11	9	7	5	5	4	4	3	3

### Assembly instruction:

The life of a rotary fitting depends considerably on a stress-free line connection. Therefore the direct connection with tubes is to be avoided.

For connection of hoses use of swivel nut connections (DIN 3865) is recommended.

We recommend short, straight hose lines (free hose length approx. 5x hose O. D.). Thus shocks, vibrations etc. are absorbed.

## DG 101 Straight ball bearing rotary union

EO 24° cone end / EO 24° cone end

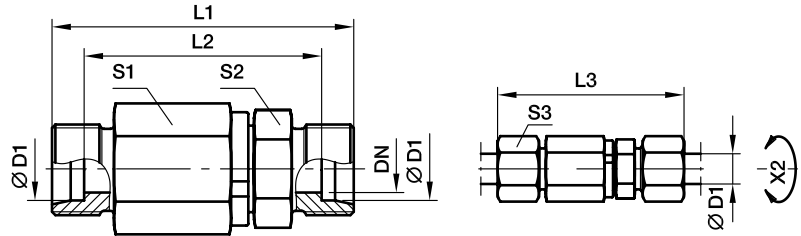

X2) Axis

Series	D1 	DN	L1	L2	L3	S1	S2	S3	Weight g/1 piece	Order code*	CF <sup>1)</sup>
S <sup>4)</sup>	06	5.0	61	47	76	22.0	17	17.0	113	<b>DG101/06SOMD</b>	Pressure ratings see chart 1
	08	5.0	61	47	76	22.0	17	19.0	118	<b>DG101/08SOMD</b>	
	12	9.5	72	57	89	30.0	24	24.0	258	<b>DG101/12SOMD</b>	
	16	9.5	74	57	93	30.0	27	30.0	264	<b>DG101/16SOMD</b>	
	20	16.0	92	71	114	41.0	36	36.0	578	<b>DG101/20SOMD</b>	
	25	16.0	96	72	120	41.0	41	46.0	652	<b>DG101/25SOMD</b>	Pressure ratings see chart 1
	30	26.0	109	82	135	60.0	46	50.0	1321	<b>DG101/30SOMD</b>	
	38	26.0	114	82	143	60.0	55	60.0	1509	<b>DG101/38SOMD</b>	

<sup>1)</sup>Pressure shown = item deliverable

<sup>4)</sup>S = heavy series

$\frac{PN \text{ (bar)}}{10} = PN \text{ (MPa)}$

Delivery without nut and ring. Information on ordering complete fittings or alternative sealing materials see page 17.

\*Please add the **suffixes** below according to the material/surface required.

Order code suffixes			
Material	Suffix surface and material	Example	Standard sealing material (no additional suffix needed)
Steel, zinc plated, Cr(VI)-free	CF	DG101/06SOMDCF	VIT

## DG 102-R Straight male stud ball bearing rotary union

Male BSPP thread – ED-seal (ISO 1179) / EO 24° cone end

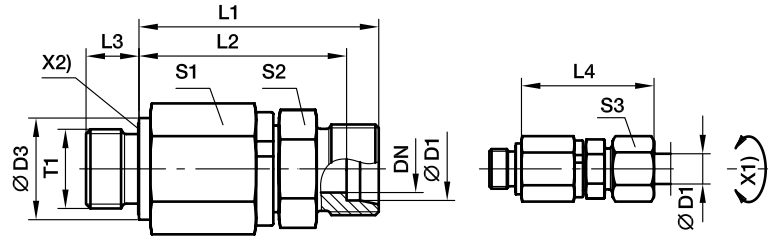

X1) Axis  
X2) Eolastic-sealing

Series	D1	T1	DN	D3	L1	L2	L3	L4	S1	S2	S3	Weight g/1 piece	Order code*	CF <sup>1)</sup>
S <sup>4)</sup>	06	G 1/4 A	5.0	19	49	42.0	12	57.0	22	17	17	110	DG102/06SROMD	Pressure ratings see chart 1
	08	G 1/4 A	5.0	19	49	42.0	12	57.0	22	17	19	116	DG102/08SROMD	
	12	G 3/8 A	9.5	22	60	52.5	12	69.0	30	24	24	243	DG102/12SROMD	
	16	G 1/2 A	9.5	27	60	51.5	14	70.0	30	27	30	256	DG102/16SROMD	
	20	G 3/4 A	16.0	32	76	65.5	16	87.5	41	36	36	558	DG102/20SROMD	Pressure ratings see chart 1
	25	G 1 A	16.0	40	78	66.0	18	90.5	41	41	46	853	DG102/25SROMD	
	30	G 1 1/4 A	26.0	50	89	75.5	20	102.0	60	46	50	1312	DG102/30SROMD	
	38	G 1 1/2 A	26.0	55	92	76.0	22	107.0	60	55	60	1494	DG102/38SROMD	

<sup>1)</sup>Pressure shown = item deliverable

<sup>4)</sup>S = heavy series

$\frac{PN \text{ (bar)}}{10} = PN \text{ (MPa)}$

Delivery without nut and ring. Information on ordering complete fittings or alternative sealing materials see page 17.

\*Please add the **suffixes** below according to the material/surface required.

Order code suffixes			
Material	Suffix surface and material	Example	Standard sealing material (no additional suffix needed)
Steel, zinc plated, Cr(VI)-free	CF	DG102/06SROMDCF	VIT/NBR

## DG 102-M Straight male stud ball bearing rotary union

Male metric thread – ED-seal (ISO 9974) / EO 24° cone end

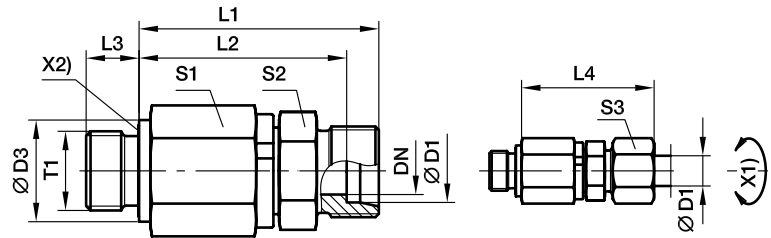

X1) Axis  
X2) Eolastic-sealing

Series	D1	T1	DN	D3	L1	L2	L3	L4	S1	S2	S3	Weight g/1 piece	Order code*	CF <sup>1)</sup>
S <sup>4)</sup>	06	M 14×1.5	5.0	19	49	42.0	12	57.0	22	17	17	112	DG102/06SMOMD	Pressure ratings see chart 1
	08	M 14×1.5	5.0	19	49	42.0	12	57.0	22	17	19	113	DG102/08SMOMD	
	12	M 18×1.5	9.5	24	60	52.5	12	69.0	30	24	24	245	DG102/12SMOMD	
	16	M 22×1.5	9.5	27	60	51.5	14	70.0	30	27	30	259	DG102/16SMOMD	
	20	M 27×2.0	16.0	32	76	65.5	16	87.5	41	36	36	558	DG102/20SMOMD	
	25	M 33×2.0	16.0	40	78	66.0	18	90.5	41	41	46	637	DG102/25SMOMD	Pressure ratings see chart 1
	30	M 42×2.0	26.0	50	89	75.5	20	102.0	60	46	50	1316	DG102/30SMOMD	
	38	M 48×2.0	26.0	55	92	76.0	22	107.0	60	55	60	1491	DG102/38SMOMD	

<sup>1)</sup>Pressure shown = item deliverable

<sup>4)</sup>S = heavy series

$\frac{PN \text{ (bar)}}{10} = PN \text{ (MPa)}$

Delivery without nut and ring. Information on ordering complete fittings or alternative sealing materials see page 17.

\*Please add the **suffixes** below according to the material/surface required.

Order code suffixes			
Material	Suffix surface and material	Example	Standard sealing material (no additional suffix needed)
Steel, zinc plated, Cr(VI)-free	CF	DG102/06SMOMDCF	VIT/NBR



## DG 103 Elbow ball bearing rotary union

EO 24° cone end / EO 24° cone end

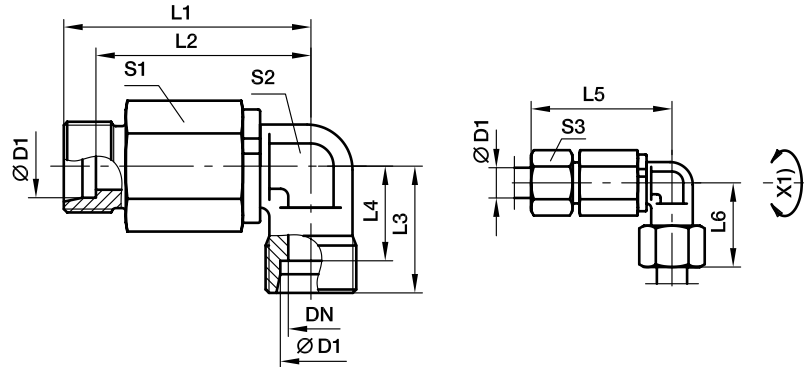

X2) Axis

Series	D1	DN	L1	L2	L3	L4	L5	L6	S1	S2	S3	Weight g/1 piece	Order code*	CF <sup>1)</sup>
S <sup>4)</sup>	06	5.0	51.5	59.0	23	16.0	44.5	16.0	22	17	17	134	<b>DG103/06SOMD</b>	Pressure ratings see chart 1
	08	5.0	51.5	59.0	24	17.0	44.5	17.0	22	17	19	141	<b>DG103/08SOMD</b>	
	12	9.5	63.0	72.0	29	21.5	55.5	21.5	30	22	24	296	<b>DG103/12SOMD</b>	
	16	9.5	63.0	73.0	33	24.5	54.5	24.5	30	22	30	298	<b>DG103/16SOMD</b>	
	20	16.0	83.0	94.5	37	26.5	72.5	26.5	41	36	36	772	<b>DG103/20SOMD</b>	
	25	16.0	83.0	95.5	42	30.0	71.0	30.0	41	36	46	803	<b>DG103/25SOMD</b>	Pressure ratings see chart 1
	30	26.0	102.5	116.0	49	35.5	89.0	35.5	60	50	50	1722	<b>DG103/30SOMD</b>	
	38	26.0	102.5	117.0	57	41.0	86.5	41.0	60	50	60	1931	<b>DG103/38SOMD</b>	

<sup>1)</sup>Pressure shown = item deliverable

<sup>4)</sup>S = heavy series

$\frac{PN \text{ (bar)}}{10} = PN \text{ (MPa)}$

Delivery without nut and ring. Information on ordering complete fittings or alternative sealing materials see page 17.

\*Please add the **suffixes** below according to the material/surface required.

Order code suffixes			
Material	Suffix surface and material	Example	Standard sealing material (no additional suffix needed)
Steel, zinc plated, Cr(VI)-free	CF	DG103/06SOMDCF	VIT

## DG 104-R Elbow male stud ball bearing rotary union

Male BSPP thread – ED-seal (ISO 1179) / EO 24° cone end

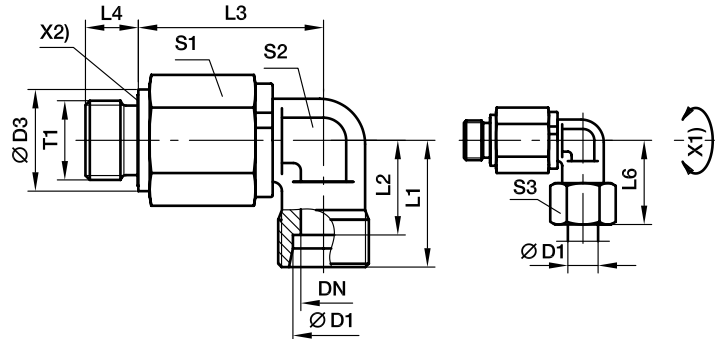

X1) Axis  
X2) Elastomeric-sealing

Series	D1	T1	DN	D3	L1	L2	L3	L4	L6	S1	S2	S3	Weight g/1 piece	Order code*	CF <sup>1)</sup>
S <sup>4)</sup>	06	G 1/4 A	05	19	23	16.0	39.5	12	31	22	17	17	131	<b>DG104/06SROMD</b>	Pressure ratings see chart 1
	08	G 1/4 A	05	19	24	17.0	39.5	12	32	22	17	19	135	<b>DG104/08SROMD</b>	
	12	G 3/8 A	10	22	29	21.5	51.0	12	38	30	22	24	284	<b>DG104/12SROMD</b>	
	16	G 1/2 A	10	27	33	24.5	49.0	14	43	30	22	30	284	<b>DG104/16SROMD</b>	
	20	G 3/4 A	16	32	37	26.5	67.0	16	48	41	36	36	752	<b>DG104/20SROMD</b>	
25	G 1 A	16	40	42	30.0	65.0	18	54	41	36	46	789	<b>DG104/25SROMD</b>	Pressure ratings see chart 1	
30	G 1 1/4 A	26	50	49	35.5	82.5	20	62	60	50	50	1713	<b>DG104/30SROMD</b>		
38	G 1 1/2 A	26	55	57	41.0	80.5	22	72	60	50	60	1915	<b>DG104/38SROMD</b>		

<sup>1)</sup>Pressure shown = item deliverable

<sup>4)</sup>S = heavy series

$\frac{PN \text{ (bar)}}{10} = PN \text{ (MPa)}$

Delivery without nut and ring. Information on ordering complete fittings or alternative sealing materials see page 17.

\*Please add the **suffixes** below according to the material/surface required.

Order code suffixes			
Material	Suffix surface and material	Example	Standard sealing material (no additional suffix needed)
Steel, zinc plated, Cr(VI)-free	CF	DG104/06SROMDCF	VIT/NBR

## DG 104-M Elbow male stud ball bearing rotary union

Male metric thread – ED-seal (ISO 9974) / EO 24° cone end

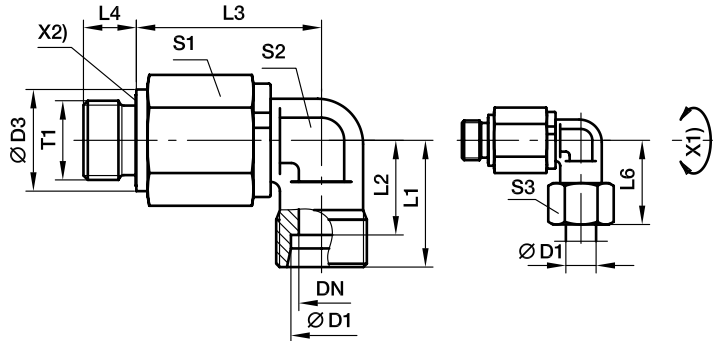

X1) Axis  
X2) Eolastic-sealing

Series	D1	T1	DN	D3	L1	L2	L3	L4	L6	S1	S2	S3	Weight g/1 piece	Order code*	CF <sup>1)</sup>
S <sup>4)</sup>	06	M 14×1.5	05	19	23	16.0	39.5	12	31	22	17	17	132	DG104/06SMOMD	Pressure ratings see chart 1
	08	M 14×1.5	05	19	24	17.0	39.5	12	32	22	17	19	136	DG104/08SMOMD	
	12	M 18×1.5	10	22	29	21.5	51.0	12	38	30	22	24	286	DG104/12SMOMD	
	16	M 22×1.5	10	27	33	24.5	49.0	14	43	30	22	30	287	DG104/16SMOMD	
	20	M 27×2.0	16	32	37	26.5	67.0	16	48	41	36	36	752	DG104/20SMOMD	
	25	M 33×2.0	16	40	42	30.0	65.0	18	54	41	36	46	788	DG104/25SMOMD	Pressure ratings see chart 1
	30	M 42×2.0	26	50	49	35.5	82.5	20	62	60	50	50	1717	DG104/30SMOMD	
	38	M 48×2.0	26	55	57	41.0	80.5	22	72	60	50	60	1913	DG104/38SMOMD	

<sup>1)</sup>Pressure shown = item deliverable

<sup>4)</sup>S = heavy series

$\frac{PN \text{ (bar)}}{10} = PN \text{ (MPa)}$

Delivery without nut and ring. Information on ordering complete fittings or alternative sealing materials see page 17.

\*Please add the **suffixes** below according to the material/surface required.

Order code suffixes			
Material	Suffix surface and material	Example	Standard sealing material (no additional suffix needed)
Steel, zinc plated, Cr(VI)-free	CF	DG104/06SMOMDCF	VIT/NBR

## DG 105 Double elbow ball bearing rotary union

EO 24° cone end / EO 24° cone end

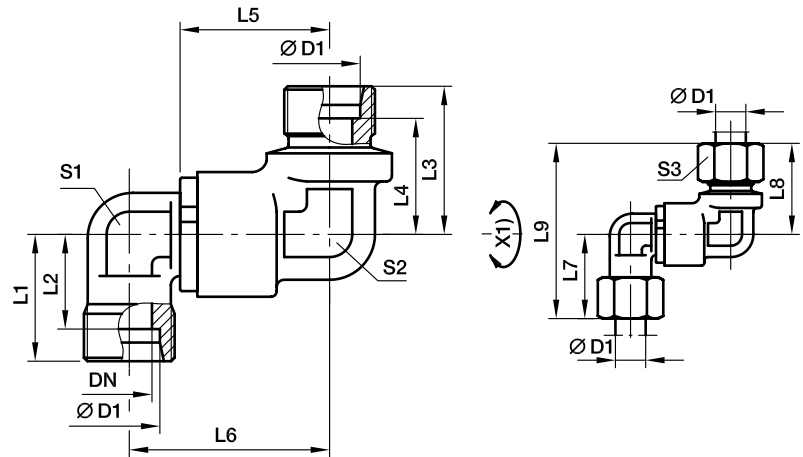

X1) Axis

Series	D1	DN	L1	L2	L3	L4	L5	L6	L7	L8	L9	S1	S2	S3	Weight g/1 piece	Order code*	CF <sup>1)</sup>
S <sup>4)</sup>	12	9.5	39.5	26.5	43	21.5	38	81	53.0	24	22	24	29	50.5	384	<b>DG105/12SOMD</b>	Pressure ratings see chart 1
	16	9.5	39.5	25.5	44	24.5	43	87	53.0	30	22	24	33	52.5	377	<b>DG105/16SOMD</b>	
	20	16.0	56.5	39.5	61	26.5	48	109	76.0	36	36	32	37	71.5	1015	<b>DG105/20SOMD</b>	
	25	16.0	56.5	38.0	62	30.0	54	116	76.0	46	36	32	42	74.0	1034	<b>DG105/25SOMD</b>	
	30	26.0	65.0	44.5	71	35.5	62	133	92.5	50	50	50	49	84.5	2344	<b>DG105/30SOMD</b>	
	38	26.0	65.0	42.0	73	41.0	72	145	92.5	60	50	50	57	89.0	2485	<b>DG105/38SOMD</b>	

<sup>1)</sup>Pressure shown = item deliverable

<sup>4)</sup>S = heavy series

$\frac{PN \text{ (bar)}}{10} = PN \text{ (MPa)}$

Delivery without nut and ring. Information on ordering complete fittings or alternative sealing materials see page 17.

\*Please add the **suffixes** below according to the material/surface required.

Order code suffixes			
Material	Suffix surface and material	Example	Standard sealing material (no additional suffix needed)
Steel, zinc plated, Cr(VI)-free	CF	DG105/12SOMDCF	VIT

### DG 106-R Double elbow male stud ball bearing rotary union

Male BSPP thread – ED-seal (ISO 1179) / EO 24° cone end  
 (Adjustable at male thread axis, consisting of DG105 + EGE)

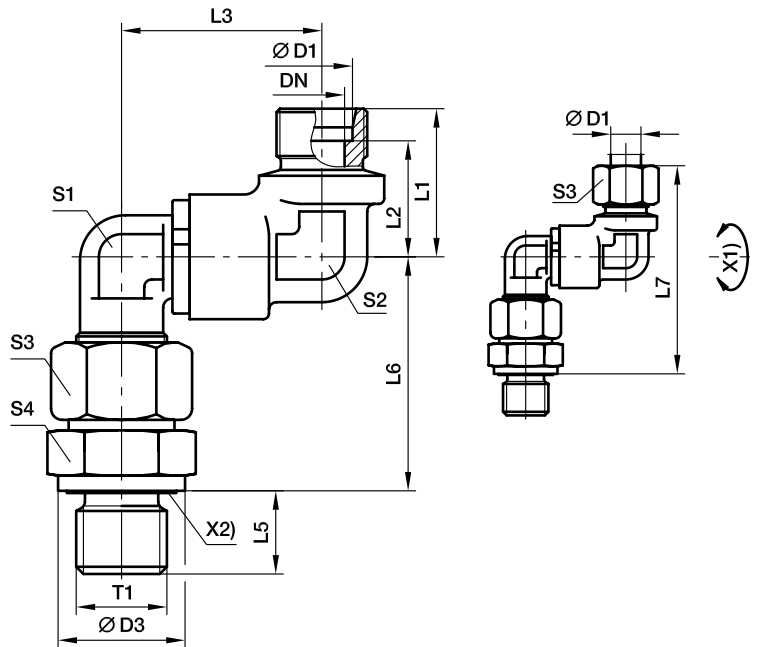

X1) Axis  
 X2) Eolastic-sealing

Series	D1	T1	DN	D3	L1	L2	L3	L5	L6	L7	S1	S2	S3	S4	Weight g/1 piece	Order code*	CF <sup>1)</sup>
S <sup>4)</sup>	12	G 3/8 A	9.5	24	34	26.5	53.0	12	55.5	99	24	22	24	22	484	<b>DG106/12SROMD</b>	Pressure ratings see chart 1
	16	G 1/2 A	9.5	27	34	25.5	53.0	14	61.5	105	24	24	30	27	547	<b>DG106/16SROMD</b>	
	20	G 3/4 A	16.0	32	50	39.5	76.0	16	69.5	131	36	32	36	32	1288	<b>DG106/20SROMD</b>	
	25	G 1 A	16.0	40	50	38.0	76.0	18	78.0	140	36	32	46	41	1528	<b>DG106/25SROMD</b>	
	30	G 1 1/4 A	26.0	50	58	44.5	92.5	20	86.5	158	50	50	50	50	3004	<b>DG106/30SROMD</b>	
	38	G 1 1/2 A	26.0	55	58	42.0	92.5	22	101.0	174	50	50	60	55	3419	<b>DG106/38SROMD</b>	

<sup>1)</sup>Pressure shown = item deliverable

<sup>4)</sup>S = heavy series

$\frac{PN \text{ (bar)}}{10} = PN \text{ (MPa)}$

Delivery without nut and ring. Information on ordering complete fittings or alternative sealing materials see page 17.

\*Please add the **suffixes** below according to the material/surface required.

Order code suffixes			
Material	Suffix surface and material	Example	Standard sealing material (no additional suffix needed)
Steel, zinc plated, Cr(VI)-free	CF	DG106/06SROMDCF	VIT/NBR

### DG 106-M Double elbow male stud ball bearing rotary union

Male metric thread – ED-seal (ISO 9974) / EO 24° cone end  
 (Adjustable at male thread axis, consisting of DG105 + EGE)

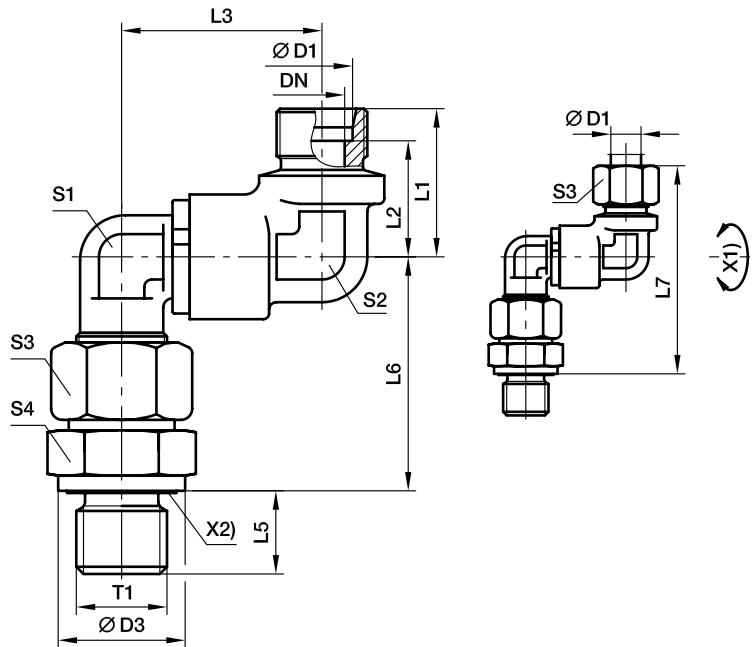

X1) Axis  
 X2) Eolastic-sealing

Series	D1	T1	DN	D3	L1	L2	L3	L5	L6	L7	S1	S2	S3	S4	Weight g/1 piece	Order code*	CF <sup>1)</sup>
S <sup>4)</sup>	12	M 18×1.5	5.0	24	34	26.5	53.0	12	55.5	99	24	22	24	24	495	<b>DG106/12SMOMD</b>	Pressure ratings see chart 1
	16	M 22×1.5	9.5	27	34	25.5	53.0	14	61.5	105	24	24	30	27	551	<b>DG106/16SMOMD</b>	
	20	M 27×2.0	16.0	32	50	39.5	76.0	16	69.5	131	36	32	36	32	1289	<b>DG106/20SMOMD</b>	
	25	M 33×2.0	16.0	40	50	38.0	76.0	18	78.0	140	36	32	46	41	1532	<b>DG106/25SMOMD</b>	
	30	M 42×2.0	26.0	50	58	44.5	92.5	20	86.5	158	50	50	50	50	3007	<b>DG106/30SMOMD</b>	
	38	M 48×2.0	26.0	55	58	42.0	92.5	22	101.0	174	50	50	60	55	3441	<b>DG106/38SMOMD</b>	

<sup>1)</sup>Pressure shown = item deliverable

<sup>4)</sup>S = heavy series

$$\frac{PN \text{ (bar)}}{10} = PN \text{ (MPa)}$$

Delivery without nut and ring. Information on ordering complete fittings or alternative sealing materials see page 17.

\*Please add the **suffixes** below according to the material/ surface required.

Order code suffixes			
Material	Suffix surface and material	Example	Standard sealing material (no additional. suffix needed)
Steel, zinc plated, Cr(VI)-free	CF	DG106/06SMOMDCF	VIT/NBR

## DG 107 Straight bulkhead ball bearing rotary union

EO 24° cone end / EO 24° cone end

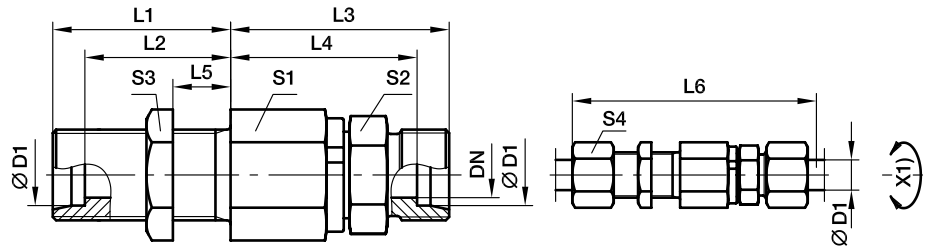

X1) Axis

Series	D1	DN	T1	L1	L2	L3	L4	L5	L6	S1	S2	S3	S4	Weight g/1 piece	Order code*	CF <sup>1)</sup>
S <sup>4)</sup>	06	5.0	M 14×1.5	23	16.0	49	42.0	5	87	22	17	19	17	134	DG107/06SOMD	Pressure ratings see chart 1
	08	5.0	M 16×1.5	23	16.0	49	42.0	5	87	22	17	22	19	143	DG107/08SOMD	
	12	9.5	M 20×1.5	23	15.5	60	52.5	5	100	30	24	27	24	291	DG107/12SOMD	
	16	9.5	M 24×1.5	26	17.5	60	51.5	5	105	30	27	32	30	328	DG107/16SOMD	
	20	16.0	M 30×2.0	39	28.5	76	65.5	15	137	41	36	41	36	710	DG107/20SOMD	Pressure ratings see chart 1
	25	16.0	M 36×2.0	42	30.0	78	66.0	15	144	41	41	46	46	847	DG107/25SOMD	
	30	26.0	M 42×2.0	44	30.5	89	75.5	15	159	60	46	50	50	1533	DG107/30SOMD	
	38	26.0	M 52×2.0	47	31.0	92	76.0	15	168	60	55	65	60	1930	DG107/38SOMD	

<sup>1)</sup> Pressure shown = item deliverable

<sup>4)</sup> S = heavy series

$$\frac{PN \text{ (bar)}}{10} = PN \text{ (MPa)}$$

Delivery without nut and ring. Information on ordering complete fittings or alternative sealing materials see page 17.

\*Please add the **suffixes** below according to the material/surface required.

Order code suffixes			
Material	Suffix surface and material	Example	Standard sealing material (no additional suffix needed)
Steel, zinc plated, Cr(VI)-free	CF	DG107/06SOMDCF	VIT

## DG 108 Elbow bulkhead ball bearing rotary union

EO 24° cone end / EO 24° cone end

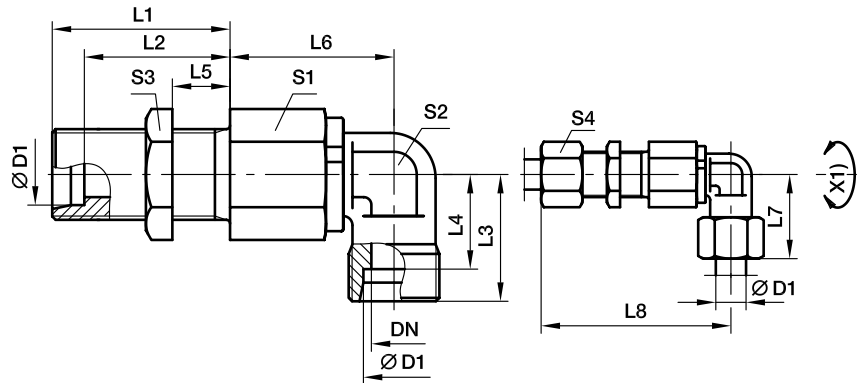

X1) Axis

Series	D1	DN	T1	L1	L2	L3	L4	L5	L6	L7	L8	S1	S2	S3	S4	Weight g/1 piece	Order code*	CF <sup>1)</sup>
S <sup>4)</sup>	06	5.0	M 14×1.5	23	16.0	23	16.0	5	39.5	31	70.0	22	17	19	17	154	<b>DG108/06SOMD</b>	Pressure ratings see chart 1
	08	5.0	M 16×1.5	23	16.0	23	17.0	5	39.5	32	70.0	22	17	22	19	166	<b>DG108/08SOMD</b>	
	12	9.5	M 20×1.5	23	15.5	29	21.5	5	51.0	38	83.0	30	22	27	24	333	<b>DG108/12SOMD</b>	
	16	9.5	M 24×1.5	26	17.5	33	24.5	5	49.0	43	85.0	30	22	32	30	354	<b>DG108/16SOMD</b>	
	20	16.0	M 30×2.0	39	28.5	37	26.5	15	67.0	48	117.5	41	36	41	36	904	<b>DG108/20SOMD</b>	
	25	16.0	M 36×2.0	42	30.0	42	30.0	15	65.0	54	119.5	41	36	46	46	999	<b>DG108/25SOMD</b>	
30	26.0	M 42×2.0	44	30.5	49	35.5	15	82.5	62	140.0	60	50	50	50	1935	<b>DG108/30SOMD</b>		
38	26.0	M 52×2.0	47	31.0	57	41.0	15	80.5	72	142.0	60	50	65	60	2351	<b>DG108/38SOMD</b>		

<sup>1)</sup>Pressure shown = item deliverable

<sup>4)</sup>S = heavy series

$\frac{PN \text{ (bar)}}{10} = PN \text{ (MPa)}$

Delivery without nut and ring. Information on ordering complete fittings or alternative sealing materials see page 17.

\*Please add the **suffixes** below according to the material/surface required.

Order code suffixes			
Material	Suffix surface and material	Example	Standard sealing material (no additional suffix needed)
Steel, zinc plated, Cr(VI)-free	CF	DG108/06SOMDCF	VIT



## DG 208-R Double elbow male stud ball bearing rotary union

Male BSPP thread – ED-seal (ISO 1179) / EO 24° cone end

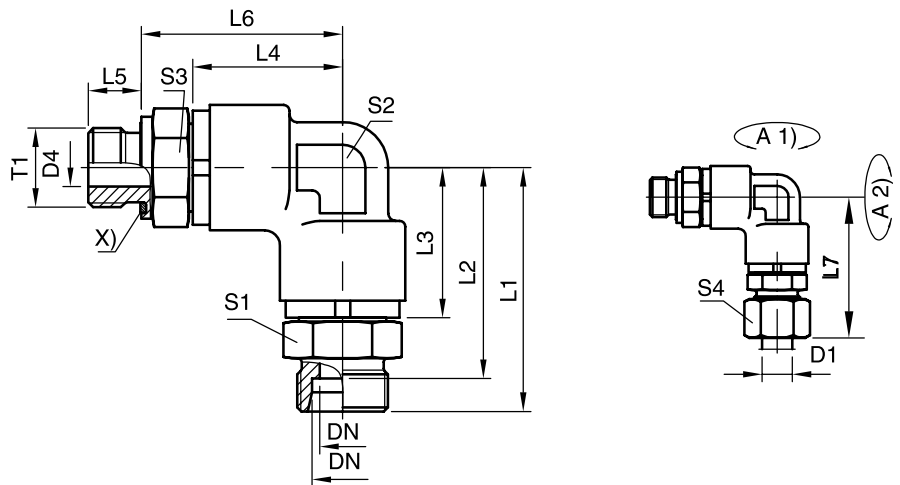

Series	D1	T1	DN	L1	L2	L3	L4	L5	L6	L7	S1	S2	S3	S4	Order code*	CF <sup>1)</sup>
S <sup>4)</sup>	12	G 3/8 A	8	61.8	54.3	39.8	39.8	12	52.5	70.3	24	24	24	24	<b>DG208/12SROMD</b>	Pressure ratings see chart 1
	16	G 1/2 A	12	64.5	56.5	39.8	39.8	14	53.0	73.5	27	24	27	30	<b>DG208/16SROMD</b>	
	20	G 3/4 A	16	84.5	74.5	56.5	56.5	16	71.5	95.5	36	32	36	36	<b>DG208/20SROMD</b>	
	25	G 1 A	16	89.5	77.5	56.5	56.5	18	74.5	100.5	41	32	41	46	<b>DG208/25SROMD</b>	
	38	G 1 1/2 A	32	104.0	88.0	65.3	65.3	22	85.3	121.5	55	50	55	60	<b>DG208/38SROMD</b>	

<sup>1)</sup>Pressure shown = item deliverable

<sup>4)</sup>S = heavy series

$\frac{PN \text{ (bar)}}{10} = PN \text{ (MPa)}$

Delivery without nut and ring. Information on ordering complete fittings or alternative sealing materials see page 17.

\*Please add the **suffixes** below according to the material/surface required.

Order code suffixes			
Material	Suffix surface and material	Example	Standard sealing material (no additional suffix needed)
Steel, zinc plated, Cr(VI)-free	CF	DG208/12SROMDCF	VIT



## DVGE-R Straight male stud plain bearing rotary union

Male BSPP thread – ED-seal / EO 24° cone end

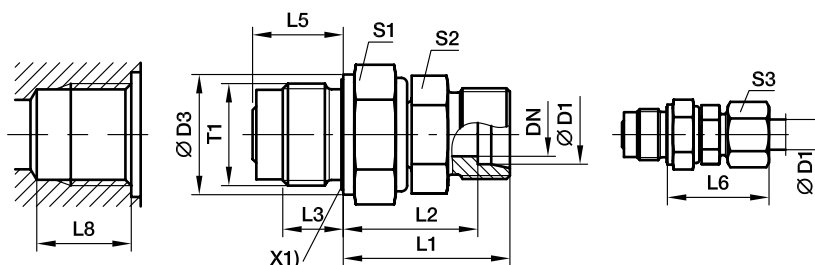

X1) Eolastic-sealing

L8 larger than DIN 3852  
chart page Q22

Series	D1 	T1	DN	D3	L1	L2	L3	L5	L6	S1	S2	S3	Weight g/1 piece	Order code*	PN (bar) <sup>1)</sup>	
															CF	VIT
L <sup>3)</sup>	06	G 1/4 A	4.0	19	28.0	21.0	12	18.0	40	19	12	14	43	DVGE06LROMD	40	40
	08	G 1/4 A	5.0	19	28.0	21.0	12	18.0	40	19	14	17	44	DVGE08LROMD	40	40
	10	G 3/8 A	6.0	22	32.0	25.0	12	18.0	40	24	17	19	74	DVGE10LROMD	40	40
	12	G 1/2 A	8.0	27	34.0	27.0	14	21.0	42	27	19	22	116	DVGE12LROMD	40	40
	15	G 3/4 A	10.0	32	39.0	32.0	16	24.0	47	32	24	27	214	DVGE15LROMD	40	40
	18	G 1 A	16.0	40	42.5	35.0	18	27.5	51	41	27	32	337	DVGE18LROMD	40	40
	22	G 1 A	16.0	40	46.5	39.0	18	27.5	55	41	32	36	376	DVGE22LROMD	40	40
	28	G 1 1/4 A	22.0	50	48.0	40.5	20	31.0	57	50	41	41	586	DVGE28LROMD	40	40
35	G 1 1/2 A	25.0	55	55.0	44.5	22	35.0	66	55	46	50	868	DVGE35LROMD	40	40	
S <sup>4)</sup>	06	G 1/4 A	4.0	19	30.0	23.0	12	18.0	38	19	14	17	50	DVGE06SROMD	100	100
	08	G 1/4 A	5.0	19	31.0	24.0	12	18.0	39	19	17	19	55	DVGE08SROMD	100	100
	10	G 3/8 A	6.0	22	34.0	26.5	12	18.0	43	24	19	22	85	DVGE10SROMD	100	100
	12	G 1/2 A	8.0	27	36.0	28.5	14	21.0	45	27	22	24	134	DVGE12SROMD	100	100
	14	G 3/4 A	10.0	32	41.0	33.0	16	24.0	51	32	24	27	220	DVGE14SROMD	100	100
	16	G 3/4 A	10.0	32	42.0	33.5	16	24.0	52	32	27	30	230	DVGE16SROMD	100	100
	20	G 1 A	16.0	40	48.5	38.0	18	27.5	60	41	32	36	385	DVGE20SROMD	100	100
	25	G 1 A	16.0	40	52.5	40.5	18	27.5	65	41	41	46	483	DVGE25SROMD	100	100
	30	G 1 1/4 A	22.0	50	55.0	41.5	20	31.0	68	50	46	50	691	DVGE30SROMD	100	100
	38	G 1 1/2 A	25.0	55	63.0	47.0	22	35.0	78	55	55	60	1080	DVGE38SROMD	100	100

<sup>1)</sup> Pressure shown = item deliverable

<sup>3)</sup> L = light series; <sup>4)</sup> S = heavy series

$\frac{PN \text{ (bar)}}{10} = PN \text{ (MPa)}$

Delivery without nut and ring. Information on ordering complete fittings or alternative sealing materials see page 17.

\*Please add the **suffixes** below according to the material/surface required.

Order code suffixes			
Material	Suffix surface and material	Example	Standard sealing material (no additional suffix needed)
Steel, zinc plated, Cr(VI)-free	CF	DVGE06LROMDCF	NBR
FKM	VITCF	DVGE06LROMDVITCF	

## DVGE-M Straight male stud plain bearing rotary union

Male metric thread – ED-seal / EO 24° cone end

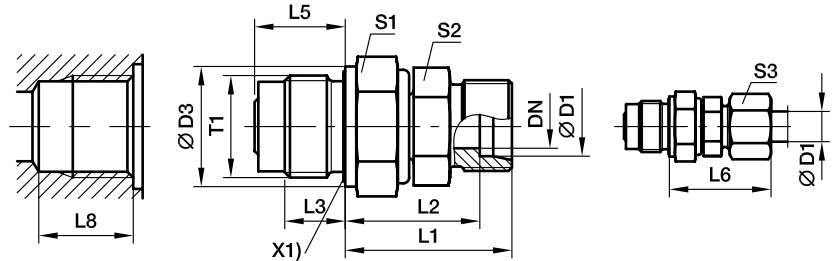

X1) Eolastic-sealing

L8 larger than DIN 3852  
chart page Q22

Series	D1	T1	DN	D3	L1	L2	L3	L5	L6	S1	S2	S3	Weight g/1 piece	Order code*	PN (bar) <sup>1)</sup>	
															CF	VIT
L <sup>3)</sup>	06	M 14×1.5	4.0	19	27.0	20.0	12	18.0	27	19	12	14	44	<b>DVGE06LMOMD</b>	40	40
	08	M 14×1.5	5.0	19	28.0	21.0	12	18.0	29	19	12	17	45	<b>DVGE08LMOMD</b>	40	40
	10	M 18×1.5	6.0	24	33.0	26.0	12	18.0	30	24	14	19	87	<b>DVGE10LMOMD</b>	40	40
	12	M 22×1.5	8.0	27	34.0	27.0	14	21.0	32	27	17	22	120	<b>DVGE12LMOMD</b>	40	40
	15	M 27×2.0	10.0	32	40.0	33.0	16	24.0	36	32	19	27	215	<b>DVGE15LMOMD</b>	40	40
	18	M 33×2.0	16.0	40	45.0	37.5	18	27.5	40	41	27	32	349	<b>DVGE18LMOMD</b>	40	40
	22	M 33×2.0	16.0	40	47.0	39.5	18	27.5	44	41	27	36	383	<b>DVGE22LMOMD</b>	40	40
	28	M 42×2.0	22.0	50	51.5	44.0	20	31.0	47	50	36	41	590	<b>DVGE28LMOMD</b>	40	40
	35	M 48×2.0	25.0	55	64.5	54.0	22	35.0	56	55	41	50	876	<b>DVGE35LMOMD</b>	40	40
	S <sup>4)</sup>	06	M 14×1.5	4.0	19	28.0	21.0	12	18.0	31	19	12	17	51	<b>DVGE06SMOMD</b>	100
08		M 14×1.5	5.0	19	29.0	22.0	12	18.0	32	19	14	19	56	<b>DVGE08SMOMD</b>	100	100
10		M 18×1.5	6.0	24	34.5	27.0	12	18.0	34	24	17	22	98	<b>DVGE10SMOMD</b>	100	100
12		M 22×1.5	8.0	27	35.5	28.0	14	21.0	38	27	17	24	139	<b>DVGE12SMOMD</b>	100	100
16		M 27×2.0	10.0	32	42.5	34.0	16	24.0	43	32	24	30	239	<b>DVGE16SMOMD</b>	100	100
20		M 33×2.0	16.0	40	50.0	39.5	18	27.5	48	41	27	36	385	<b>DVGE20SMOMD</b>	100	100
25		M 33×2.0	16.0	40	54.5	42.5	18	27.5	54	41	36	46	494	<b>DVGE25SMOMD</b>	100	100
30		M 42×2.0	22.0	50	61.5	48.0	20	31.0	62	50	41	50	695	<b>DVGE30SMOMD</b>	100	100
38		M 48×2.0	25.0	55	71.0	55.0	22	35.0	72	55	50	60	1088	<b>DVGE38SMOMD</b>	100	100

<sup>1)</sup> Pressure shown = item deliverable

<sup>3)</sup> L = light series; <sup>4)</sup> S = heavy series

$\frac{\text{PN (bar)}}{10} = \text{PN (MPa)}$

Delivery without nut and ring. Information on ordering complete fittings or alternative sealing materials see page 17.

\*Please add the **suffixes** below according to the material/surface required.

Order code suffixes			
Material	Suffix surface and material	Example	Standard sealing material (no additional suffix needed)
Steel, zinc plated, Cr(VI)-free	CF	DVGE06LMOMDCF	NBR
FKM	VITCF	DVGE06LMOMDVITCF	

## DVWE-R Elbow male stud plain bearing rotary union

Male BSPP thread – ED-seal / EO 24° cone end

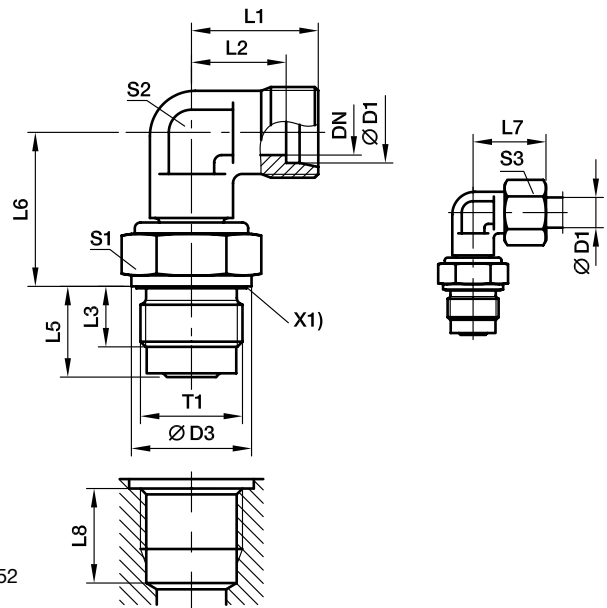

L8 larger than DIN 3852 chart page Q22

X1) Eolastic-sealing

Series	D1	T1	DN	D3	L1	L2	L3	L5	L6	L7	S1	S2	S3	Weight g/1 piece	Order code*	PN (bar) <sup>1)</sup>	CF	VIT
L <sup>3)</sup>	06	G 1/4 A	4	19	19	12.0	12	18.0	20.0	27	19	12	14	50	DVWE06LROMD	40	40	
	08	G 1/4 A	5	19	21	14.0	12	18.0	21.0	29	19	12	17	50	DVWE08LROMD	40	40	
	10	G 3/8 A	6	22	22	15.0	12	18.0	26.0	30	24	14	19	83	DVWE10LROMD	40	40	
	12	G 1/2 A	8	27	24	17.0	14	21.0	27.0	32	27	17	22	129	DVWE12LROMD	40	40	
	15	G 3/4 A	10	32	28	21.0	16	24.0	33.0	36	32	19	27	232	DVWE15LROMD	40	40	
	18	G 1 A	16	40	31	23.5	18	27.5	37.5	40	41	27	32	393	DVWE18LROMD	40	40	
	22	G 1 A	16	40	35	27.5	18	27.5	39.5	44	41	27	36	406	DVWE22LROMD	40	40	
	28	G 1 1/4 A	22	50	38	30.5	20	31.0	44.0	47	50	36	41	664	DVWE28LROMD	40	40	
	35	G 1 1/2 A	25	55	45	34.5	22	35.0	54.0	56	55	41	50	1005	DVWE35LROMD	40	40	
	S <sup>4)</sup>	06	G 1/4 A	4	19	23	16.0	12	18.0	21.0	31	19	12	17	58	DVWE06SROMD	100	100
08		G 1/4 A	5	19	24	17.0	12	18.0	22.0	32	19	14	19	65	DVWE08SROMD	100	100	
10		G 3/8 A	6	22	25	17.5	12	18.0	27.0	34	24	17	22	103	DVWE10SROMD	100	100	
12		G 1/2 A	8	27	29	21.5	14	21.0	28.0	38	27	17	24	152	DVWE12SROMD	100	100	
14		G 3/4 A	10	32	30	22.0	16	24.0	33.0	40	32	19	27	236	DVWE14SROMD	100	100	
16		G 3/4 A	10	32	33	24.5	16	24.0	34.0	43	32	24	30	276	DVWE16SROMD	100	100	
20		G 1 A	16	40	37	26.5	18	27.5	39.5	48	41	27	36	415	DVWE20SROMD	100	100	
25		G 1 A	16	40	42	30.0	18	27.5	42.5	54	41	36	46	569	DVWE25SROMD	100	100	
30		G 1 1/4 A	22	50	49	35.5	20	31.0	48.0	62	50	41	50	886	DVWE30SROMD	100	100	
38		G 1 1/2 A	25	55	57	41.0	22	35.0	55.0	72	55	50	60	1375	DVWE38SROMD	100	100	

<sup>1)</sup>Pressure shown = item deliverable

<sup>3)</sup>L = light series; <sup>4)</sup>S = heavy series

$$\frac{PN \text{ (bar)}}{10} = PN \text{ (MPa)}$$

Delivery without nut and ring. Information on ordering complete fittings or alternative sealing materials see page 17.

\*Please add the suffixes below according to the material/surface required.

Order code suffixes			
Material	Suffix surface and material	Example	Standard sealing material (no additional suffix needed)
Steel, zinc plated, Cr(VI)-free	CF	DVWE06LROMDCF	NBR
FKM	VITCF	DVWE06LROMDVITCF	

## DVWE-M Elbow male stud plain bearing rotary union

Male metric thread – ED-seal / EO 24° cone end

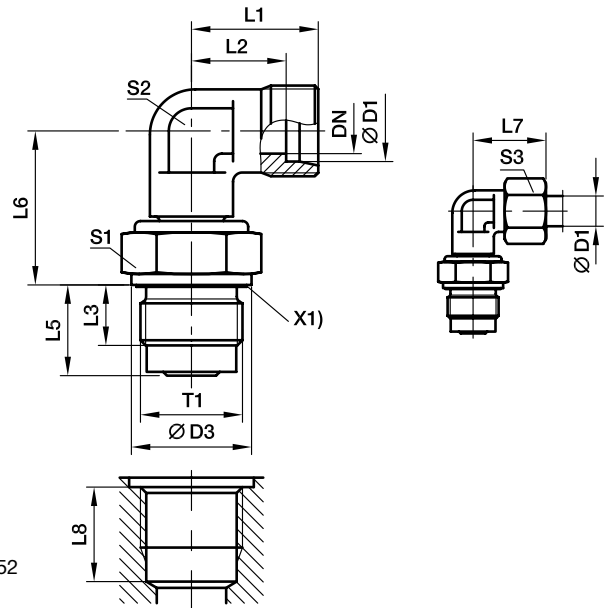

X1) Eolastic-sealing

L8 larger than DIN 3852  
chart page Q22

Series	D1 	T1	DN	D3	L1	L2	L3	L5	L6	L7	S1	S2	S3	Weight g/1 piece	Order code*	PN (bar) <sup>1)</sup>	
																CF	VIT
L <sup>3)</sup>	06	M 14×1.5	4.0	19	19	12.0	12	18.0	20.0	27	19	12	14	51	<b>DVWE06LMOMD</b>	40	40
	08	M 14×1.5	5.0	19	21	14.0	12	18.0	21.0	29	19	12	17	51	<b>DVWE08LMOMD</b>	40	40
	10	M 18×1.5	6.0	24	22	15.0	12	18.0	26.0	30	24	14	19	92	<b>DVWE10LMOMD</b>	40	40
	12	M 22×1.5	8.0	27	24	17.0	14	21.0	27.0	32	27	17	22	160	<b>DVWE12LMOMD</b>	40	40
	15	M 27×2.0	10.0	32	28	21.0	16	24.0	33.0	36	32	19	27	236	<b>DVWE15LMOMD</b>	40	40
	18	M 33×2.0	16.0	40	31	23.5	18	27.5	37.5	40	41	27	32	405	<b>DVWE18LMOMD</b>	40	40
	22	M 33×2.0	16.0	40	35	27.5	18	27.5	39.5	44	41	27	36	409	<b>DVWE22LMOMD</b>	40	40
	28	M 42×2.0	22.0	50	38	30.5	20	31.0	44.0	47	50	36	41	660	<b>DVWE28LMOMD</b>	40	40
	35	M 48×2.0	25.0	55	45	34.5	22	35.0	54.0	56	55	41	50	1012	<b>DVWE35LMOMD</b>	40	40
	S <sup>4)</sup>	06	M 14×1.5	4.0	19	23	16.0	12	18.0	21.0	31	19	12	17	59	<b>DVWE06SMOMD</b>	100
08		M 14×1.5	5.0	19	24	17.0	12	18.0	22.0	32	19	14	19	66	<b>DVWE08SMOMD</b>	100	100
10		M 18×1.5	6.0	24	25	17.5	12	18.0	27.0	34	24	17	22	113	<b>DVWE10SMOMD</b>	100	100
12		M 22×1.5	8.0	27	29	21.5	14	21.0	28.0	38	27	17	24	153	<b>DVWE12SMOMD</b>	100	100
16		M 27×2.0	10.0	32	33	24.5	16	24.0	34.0	43	32	24	30	284	<b>DVWE16SMOMD</b>	100	100
20		M 33×2.0	16.0	40	37	26.5	18	27.5	39.5	48	41	27	36	427	<b>DVWE20SMOMD</b>	100	100
25		M 33×2.0	16.0	40	42	30.0	18	27.5	42.5	54	41	36	46	581	<b>DVWE25SMOMD</b>	100	100
30		M 42×2.0	22.0	50	49	35.5	20	31.0	48.0	62	50	41	50	898	<b>DVWE30SMOMD</b>	100	100
38		M 48×2.0	25.0	55	57	41.0	22	35.0	55.0	72	55	50	60	1373	<b>DVWE38SMOMD</b>	100	100

<sup>1)</sup> Pressure shown = item deliverable

<sup>3)</sup> L = light series; <sup>4)</sup> S = heavy series

$$\frac{\text{PN (bar)}}{10} = \text{PN (MPa)}$$

Delivery without nut and ring. Information on ordering complete fittings or alternative sealing materials see page I7.

\*Please add the **suffixes** below according to the material/surface required.

Order code suffixes			
Material	Suffix surface and material	Example	Standard sealing material (no additional suffix needed)
Steel, zinc plated, Cr(VI)-free	CF	DVWE06LMOMDCF	NBR
FKM	VITCF	DVWE06LMOMDVITCF	

**Port tapping for plain bearing rotary fittings DVGE and DVWE**

**Port tapping form X**  
according to DIN 3852, part 1 and part 2  
(for parallel male studs)

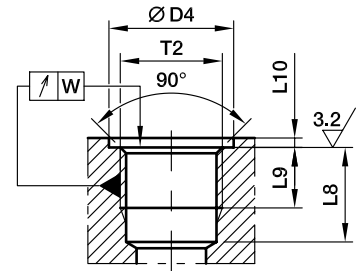

Thread d1	d4 small +0.4	a <sub>1</sub> max	L9 min	L8 min	W
M 14×1.5	20	1.5	12	19.0	0.1
M 18×1.5	25 <sup>2)</sup>	2.0	12	19.0	0.1
M 22×1.5	28	2.5	14	22.0	0.1
M 27×2.0	33	2.5	16	25.0	0.2
M 33×2.0	41 <sup>2)</sup>	2.5	18	28.5	0.2
M 42×2.0	51 <sup>2)</sup>	2.5	20	32.0	0.2
M 48×2.0	56	2.5	22	36.0	0.2
G 1/4 A	20 <sup>2)</sup>	1.5	12	19.0	0.1
G 3/8 A	23	2.0	12	19.0	0.1
G 1/2 A	28 <sup>2)</sup>	2.5	14	22.0	0.1
G 3/4 A	33	2.5	16	25.0	0.2
G 1 A	41 <sup>2)</sup>	2.5	18	28.5	0.2
G 1 1/4 A	51 <sup>2)</sup>	2.5	20	32.0	0.2
G 1 1/2 A	56	2.5	22	36.0	0.2

<sup>1)</sup> Not in DIN 3852

<sup>2)</sup> Different from DIN 3852