



## MS5536-60C

### SMD Gage Pressure Module

#### SPECIFICATIONS

- **Pressure range 0 to 60 mbar**
- **0.05 mbar Resolution**
- **Factory Calibrated (coefficients for software compensation store on-chip)**
- **16 Bit ADC**
- **3-wire serial interface**
- **Low voltage / low power**

MS5536-60C is a family of high-resolution factory calibrated pressure sensors. The devices include a piezoresistive pressure sensor and an ADC-Interface IC. The 3-wire serial interface ensures simple communication with any microcontroller. The devices provide digital pressure and temperature information as 16-Bit data word each. In addition 64-Bit of individually calibrated compensation coefficients are stored allowing for a highly accurate software compensation of process spread and temperature effects.

The devices have a very low standby current and automatically enter power down mode after each conversion. The optimum compromise of refresh rate and average current consumption can be defined by the application software.

## FEATURES

- 16-Bit ADC Resolution
- Supply voltage 2.2 V to 3.6 V
- Low supply current
- No external components required

## APPLICATIONS

- Liquid level metering
- Medical application
- Air flow measurement
- HVAC application

## BLOCK DIAGRAM

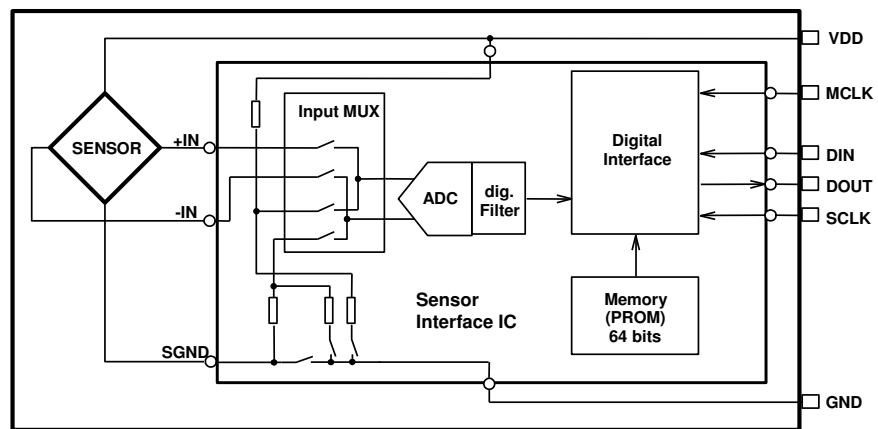

Fig. 1: Block diagram MS5536-60C

## PIN CONFIGURATION



Fig. 2: Pin configuration of MS5536-60CPJU

## PIN DESCRIPTION

Pin Name	Pin	Type	Function
N/C	1		Not Connected
VDD	2	P	Positive Supply Voltage
MCLK	3	I	Master Clock (32.768kHz)
DIN	4	I	Data Input
DOUT	5	O	Data Output
SCLK	6	I	Serial Data Clock
GND	7	G	Ground
N/C	8		Not Connected
N/C	9		Not Connected
N/C	10		Not Connected
N/C	11		Not Connected
N/C	12		Not Connected
PV	13	N	Negative Programming Voltage
PEN	14	I	Programming Enable

### NOTE

Pins 13 (PEN) and 14 (PV) are only used by the manufacturer for calibration purposes and should not be connected.

## PRESSURE UNIT CONVERSION

mbar	kPa	bar	mm Hg	PSI	atm	mm H <sub>2</sub> O	Inches H <sub>2</sub> O
60.0	6.00	0.6000	45.0	0.872	0.05921	611.9	24.086
1000.0	100.00	1.0000	750.0	14.503	0.9869	10198	401.45

## ABSOLUTE MAXIMUM RATINGS

Parameter	Symbol	Conditions	Min	Max	Unit	Notes
Supply voltage	V <sub>DD</sub>		-0.3	4	V	
Differential Overpressure	P <sub>diff</sub>			5	bar	1
Storage temperature	T <sub>S</sub>		-40	+125	°C	1

## NOTES

- Storage and operation in an environment of dry and non-corrosive gases.

## RECOMMENDED OPERATING CONDITIONS

(T<sub>a</sub> = 25 °C, V<sub>DD</sub> = 3.0 V unless noted otherwise)

Parameter	Symbol	Conditions	Min	Typ	Max	Unit
Supply voltage	V <sub>DD</sub>		2.2	3.0	3.6	V
Supply current, average (1) during conversion (2) standby (no conversion)	I <sub>avg</sub> I <sub>sc</sub> I <sub>ss</sub>	V <sub>DD</sub> = 3.0 V		4 1	0.1	μA mA μA
Current consumption into MCLK (3)		MCLK = 32.768 kHz			0.5	μA
Operating pressure range	p	Pressure Range P devices	0		60	mbar
Operating temperature range	T <sub>a</sub>		0	+25	+100	°C
Conversion time	t <sub>conv</sub>	MCLK = 32.768 kHz			35	ms
External clock signal (4)	MCLK		30.000	32.768	35.000	kHz
Duty cycle of MCLK			40/60	50/50	60/40	%
Serial data clock	SCLK				500	kHz

## NOTES

- Under the assumption of one conversion every second. Conversion means either a pressure or a temperature measurement started by a command to the serial interface of MS5536-60C.
- During conversion the sensor will be switched on and off in order to reduce power consumption; the total on time within a conversion is about 2 ms. The current specified is active only during this time.
- This value can be reduced by switching off MCLK while MS5536-60C is in standby mode.
- It is strongly recommended that a crystal oscillator be used because the device is sensitive to clock jitter. A square-wave form of the clock signal is a must.

## ELECTRICAL CHARACTERISTICS

## DIGITAL INPUTS

(T = 0 °C .. 100 °C, V<sub>DD</sub> = 2.2 V .. 3.6 V)

Parameter	Symbol	Conditions	Min	Typ	Max	Unit
Input High Voltage	V <sub>IH</sub>		80% V <sub>DD</sub>		100% V <sub>DD</sub>	V
Input Low Voltage	V <sub>IL</sub>		0% V <sub>DD</sub>		20% V <sub>DD</sub>	V
Signal Rise Time	t <sub>r</sub>			200		ns
Signal Fall Time	t <sub>f</sub>			200		ns

## DIGITAL OUTPUTS

(T = 0 °C .. 100 °C, V<sub>DD</sub> = 2.2 V .. 3.6 V)

Parameter	Symbol	Conditions	Min	Typ	Max	Unit
Output High Voltage	V <sub>OH</sub>	I <sub>source</sub> = 0.6 mA	80% V <sub>DD</sub>		100% V <sub>DD</sub>	V
Output Low Voltage	V <sub>OL</sub>	I <sub>sink</sub> = 0.6 mA	0% V <sub>DD</sub>		20% V <sub>DD</sub>	V
Signal Rise Time	t <sub>r</sub>			200		ns
Signal Fall Time	t <sub>f</sub>			200		ns

## AD-CONVERTER

(T = 0 °C .. 100 °C, V<sub>DD</sub> = 2.2 V .. 3.6 V)

Parameter	Symbol	Conditions	Min	Typ	Max	Unit
Resolution				16		Bit
Linear Range			4'000		40'000	LSB
Conversion Time		MCLK = 32.768 kHz			35	ms
INL		Within linear range	-5		+5	LSB

## PRESSURE OUTPUT CHARACTERISTICS

With the calibration data stored in the interface IC of the MS5536-60C, the following characteristics can be achieved:  
( $V_{DD} = 3.0\text{ V}$  unless noted otherwise)

Parameter	Conditions	Min	Typ	Max	Unit	Notes
Resolution			0.05		mbar	1
Pressure Accuracy	$T_a = 20 \dots 40^\circ\text{C}$ MS5536-60C-C: $p = 0 \dots 60\text{ mbar}$	-0.5		+0.5	mbar	2
	$T_a = 0 \dots +60^\circ\text{C}$ MS5536-60C-C: $p = 0 \dots 60\text{ mbar}$	-1		+1	mbar	2
Maximum Error over Temperature	$T_a = 0 \dots +100^\circ\text{C}$ $p = \text{const. (range } 0 \dots 60\text{ mbar)}$	-7		+3	mbar	3
Long-term Stability	12 months		-1		mbar	4
Maximum Error over Supply Voltage	$V_{DD} = 2.2 \dots 3.6\text{ V}$	-0.8		0.8	mbar	

### NOTES

- 1) A stable pressure reading of the given resolution requires taking the average of 2 to 8 subsequent pressure values due to noise of the ADC.
- 2) Specified values assume an offset adjustment at any given pressure e.g.  $p = 0$  prior to the measurement.
- 3) Specified values assume quadratic temperature compensation (Refer to the paragraph "second-order temperature compensation" in the section "FUNCTION").
- 4) The long-term stability is measured with non-soldered devices.

## TEMPERATURE OUTPUT CHARACTERISTICS

The temperature information is not required for most applications, but it is necessary to allow for temperature compensation of the output. Reference temperature is  $20^\circ\text{C}$ .

( $V_{DD} = 3.0\text{ V}$  unless noted otherwise)

Parameter	Conditions	Min	Typ	Max	Unit	Notes
Resolution		0.005	0.01	0.015	$^\circ\text{C}$	
Accuracy	$T_a = 20^\circ\text{C}$	-0.8		0.8	$^\circ\text{C}$	
	$T_a = 0 \dots +100^\circ\text{C}$		$\pm 2$		$^\circ\text{C}$	1
Maximum Error over Supply Voltage	$V_{DD} = 2.2 \dots 3.6\text{ V}$	-0.2		0.2	$^\circ\text{C}$	

### NOTES

- 1) With the second-order temperature compensation as described in section "FUNCTION". See next section for typical operating curves.

## TYPICAL PERFORMANCE CURVES

ADC-value D1 vs Pressure (typical)

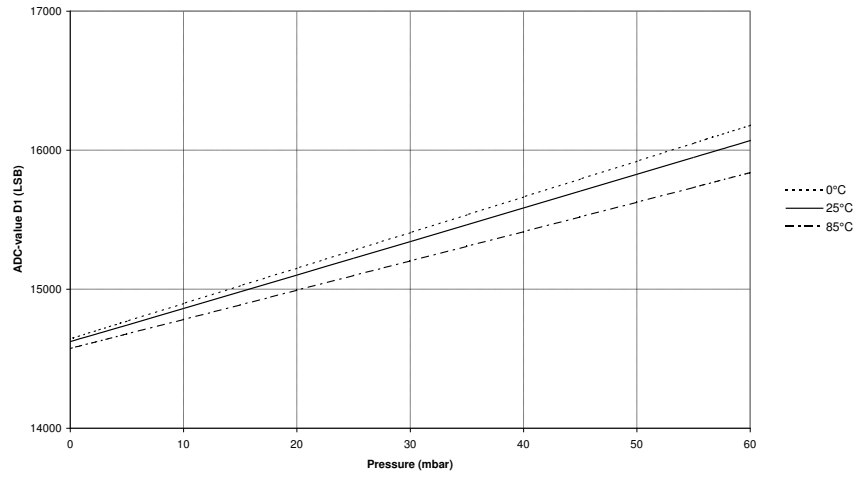

ADC-value D2 vs Temperature (typical)

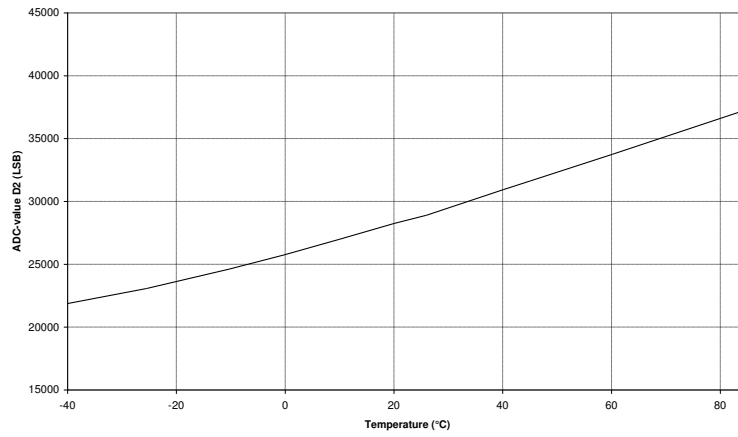

Absolute Pressure Accuracy after Calibration

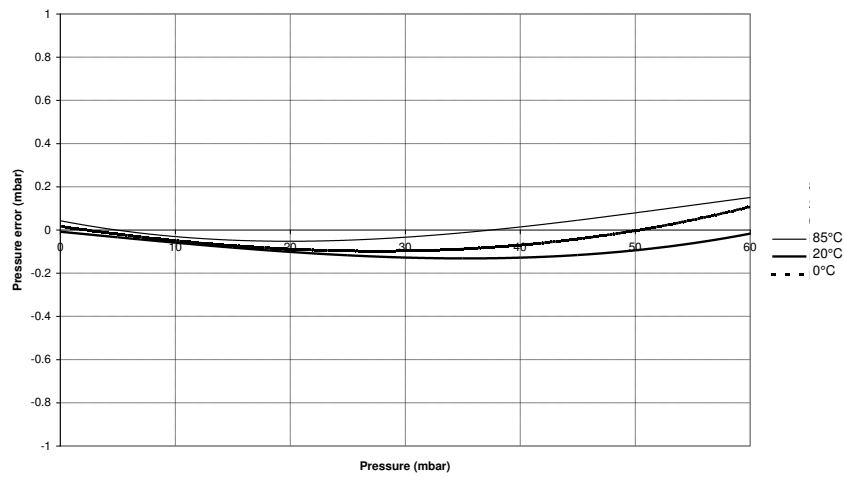

**Temperature Error Accuracy vs temperature (typical)**

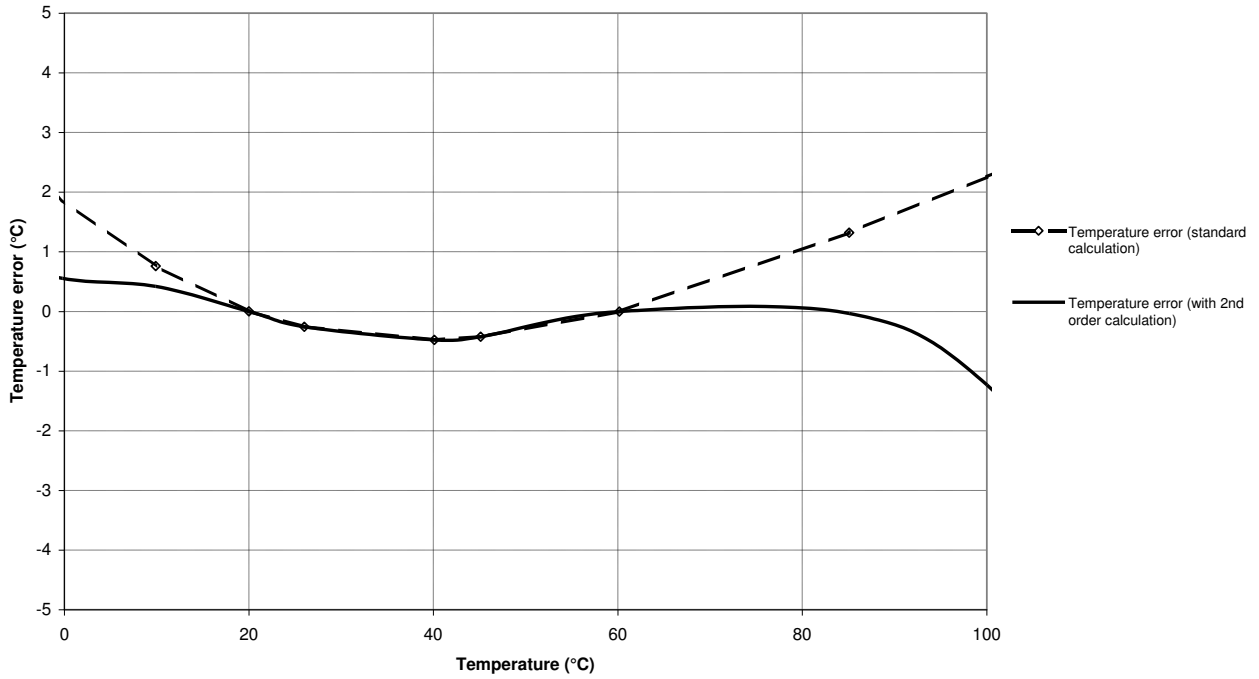

**Pressure Error Accuracy vs temperature (typical)**

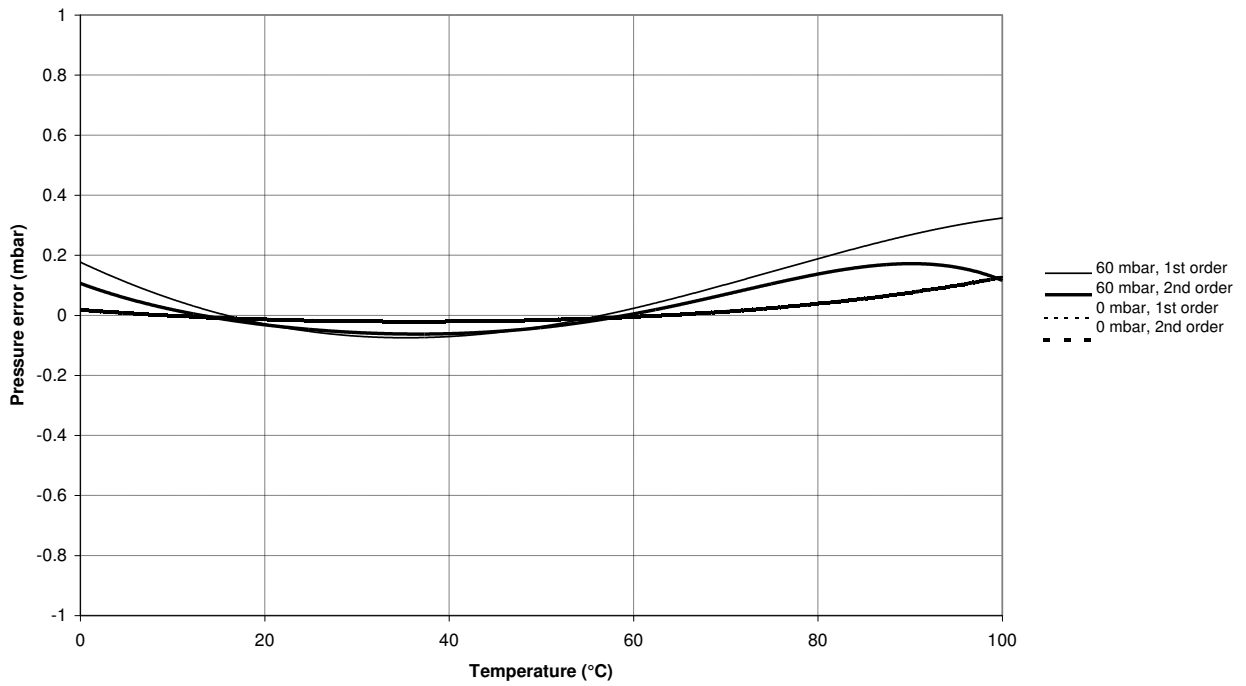



**Pressure error vs supply voltage (typical)**

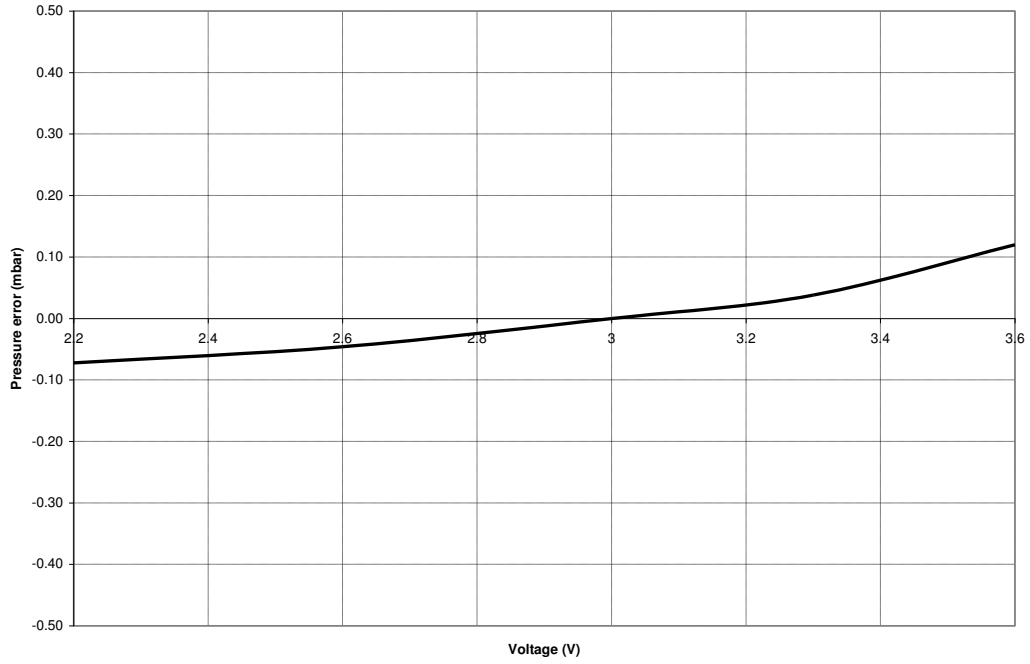

**Temperature error vs supply voltage (typical)**

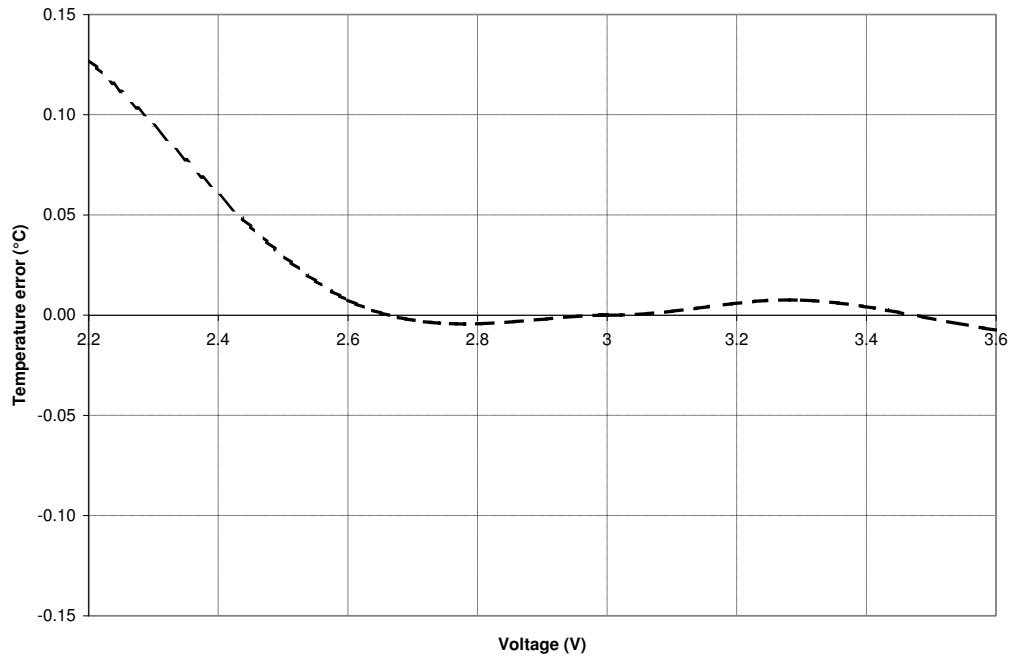

## FUNCTION

### GENERAL

The MS5536-60C consists of a piezo-resistive sensor and a sensor interface IC. The main function of the MS5536-60C is to convert the uncompensated analogue output voltage from the piezo-resistive pressure sensor to a 16-bit digital value, as well as providing a 16-bit digital value for the temperature of the sensor.

Measured pressure (16-bit) "D1"  
Measured temperature (16-bit) "D2"

As the output voltage of a pressure sensor is strongly dependent on temperature and process tolerances, it is necessary to compensate for these effects. This compensation procedure must be performed by software using an external microcontroller.

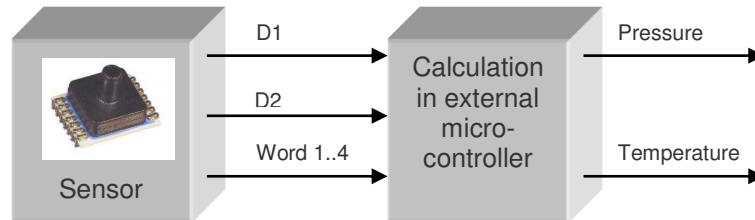

For both pressure and temperature measurement the same ADC is used (sigma delta converter):

- for the pressure measurement, the differential output voltage from the pressure sensor is converted
- for the temperature measurement, the sensor bridge resistor is sensed and converted

During both measurements the sensor will only be switched on for a very short time in order to reduce power consumption. As both, the bridge bias and the reference voltage for the ADC are derived from  $V_{DD}$ , the digital output data is independent of the supply voltage.

### FACTORY CALIBRATION

Every module is individually factory calibrated at two temperatures and two pressures. As a result, 6 coefficients necessary to compensate for process variations and temperature variations are calculated and stored in the 64-bit PROM of each module. These 64-bit (partitioned into four words of 16-bit) must be read by the microcontroller software and used in the program converting D1 and D2 into compensated pressure and temperature values.

### PRESSURE AND TEMPERATURE MEASUREMENT

The sequence of reading pressure and temperature as well as of performing the software compensation is depicted in flow chart, Fig. 3 and Fig. 5.

First WORD1 to WORD4 are read through the serial interface. This can be done once after reset of the microcontroller that interfaces to the MS5536-60C. Next the compensation coefficients C1 to C6 are extracted using Bit-wise logical- and shift-operations (refer to Fig. 4 for the Bit-pattern of word 1 to word 4).

For the pressure measurement, the microcontroller has to read the 16-Bit values for pressure (D1) and temperature (D2) via the serial interface in a loop (for instance once every second). Then, the compensated pressure is calculated out of D1, D2 and C1 to C6 according to the algorithm in Fig. 3 (possibly using quadratic temperature compensation according to Fig. 5). All calculations can be performed with signed 16-Bit variables. Results of multiplications may be up to 32-Bit long (+sign). In the flow according to Fig. 3 each multiplication is followed by a division. This division can be performed by Bit-wise shifting (divisors are to the power of 2). It is ensured that the results of these divisions are less than 65536-60C (16-Bit).

For the timing of signals to read out WORD1 to WORD4, D1, and D2 please refer to the paragraph 'Serial Interface'.

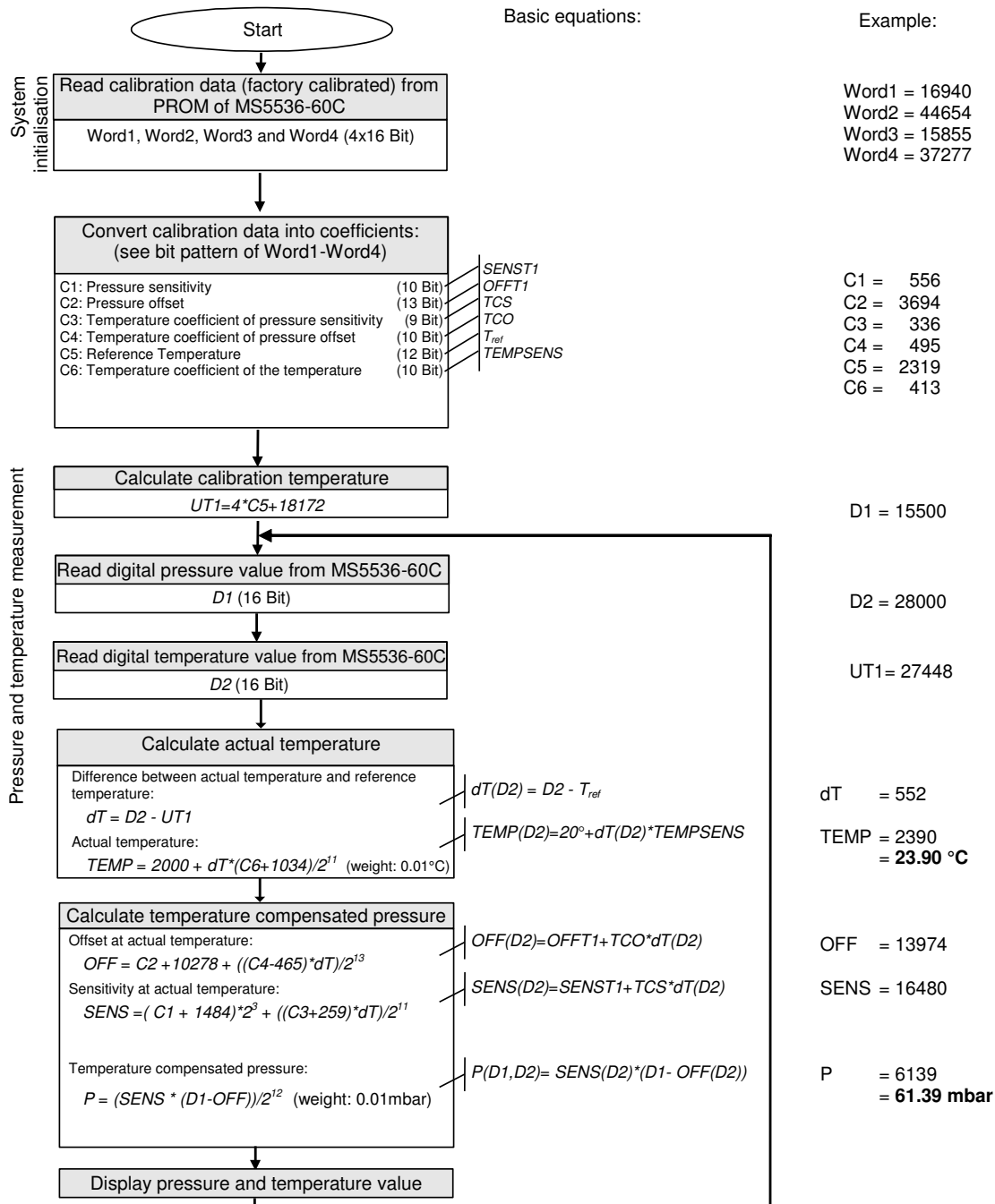

Fig. 3: Flow chart for pressure and temperature reading and software compensation

**NOTES**

- 1) Readings of D2 can be done less frequently, but the display will be less stable in this case
- 2) For a stable display of 0.1 mm Hg resolution or below, it is recommended to display the average of at least 8 subsequent pressure values.

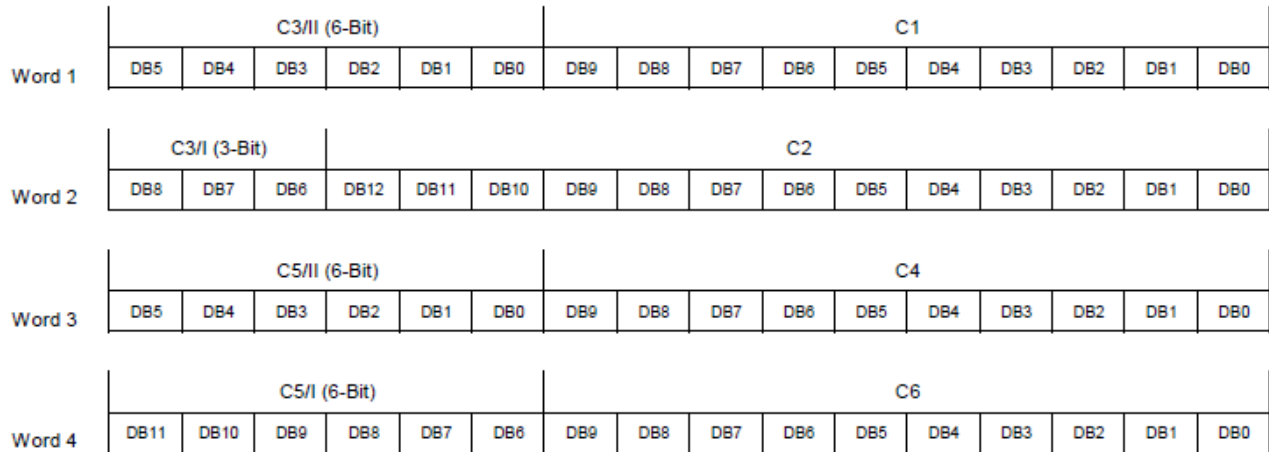

Fig. 4: Arrangement (Bit-pattern) of calibration data in Word1 to Word4

**SECOND-ORDER TEMPERATURE COMPENSATION**

In order to obtain full temperature accuracy over the whole temperature range, it is recommended to compensate for the non-linearity of the output of the temperature sensor. This can be achieved by correcting the calculated temperature and pressure by a second order correction factor. The second-order factors are calculated as follows:

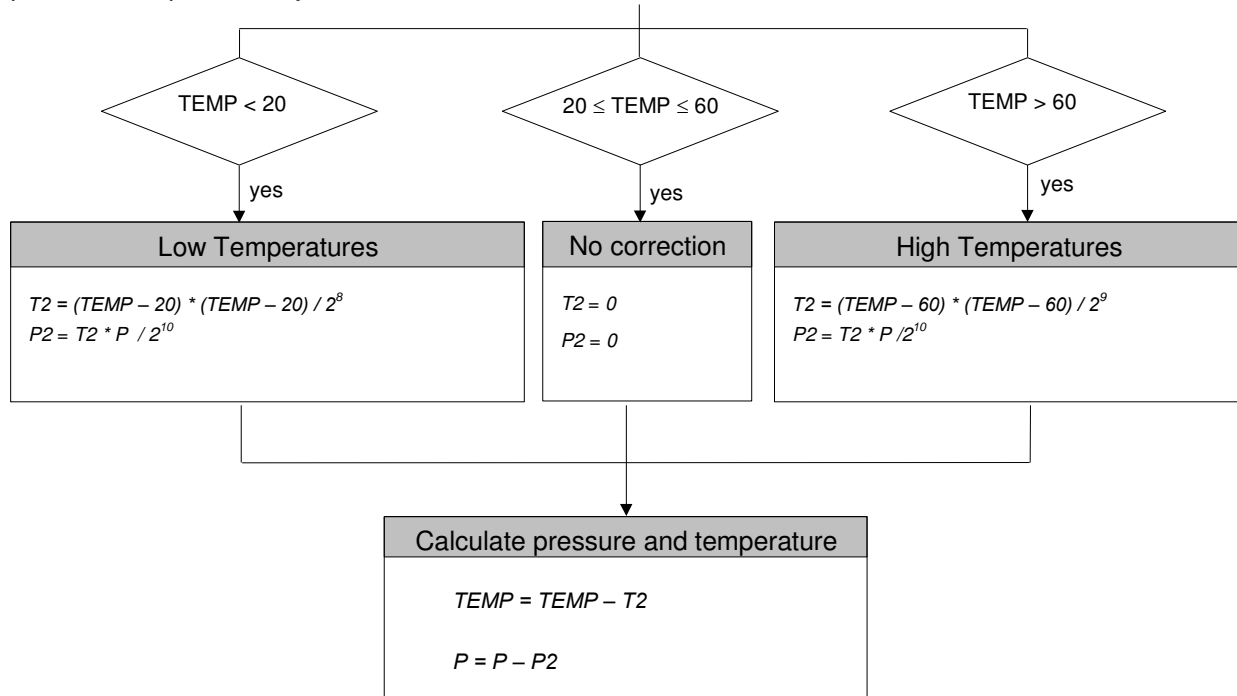

Fig. 5: Flow chart for calculating the temperature to the optimum accuracy.

**NOTE**

All pressures (P and P2) are in mbar and temperatures (TEMP and T2) are in °C.

**SERIAL INTERFACE**

The MS5536-60C communicates with microprocessors and other digital systems via a 3-wire synchronous serial interface as shown in Fig. 1. The SCLK (Serial Clock) signal initiates the communication and synchronizes the data transfer with each Bit being sampled by the MS5536-60C on the rising edge of SCLK and each Bit being sent by the MS5536-60C on the rising edge of SCLK. The data should thus be sampled by the microcontroller on the falling edge of SCLK and sent to the MS5536-60C with the falling edge of SCLK. The SCLK-signal is generated by the microprocessor's system. The digital data provided by the MS5536-60C on the DOUT pin is either the conversion result or the software calibration data. In addition the signal DOUT (Data Out) is also used to indicate the conversion status (conversion-ready signal, see below). The selection of the output data is done by sending the corresponding instruction on the pin DIN (Data Input).

Following is a list of possible output data instructions:

- Conversion start for pressure measurement and ADC-data-out "D1" (Figure 6a)
- Conversion start for temperature measurement and ADC-data-out "D2" (Figure 6b)
- Calibration data read-out sequence for word 1 and word 3 (Figure 6c)
- Calibration data read-out sequence for word 2 and word 4 (Figure 6d)
- RESET sequence (Figure 6e)

Every communication starts with an instruction sequence at Pin DIN. Fig. 6 shows the timing diagrams for the MS5536-60C. The device does not need a 'Chip select' signal. Instead there is a Start Sequence (3-Bit high) before each Setup Sequence and Stop Sequence (3-Bit low) after each Setup Sequence. The Setup Sequence consists in 4-Bit that select a reading of pressure, temperature or calibration data. In case of pressure- (D1) or temperature- (D2) reading the module acknowledges the start of a conversion by a low to high transition at Pin DOUT during the last Bit of the Stop Sequence.

Two additional clocks at SCLK are required after the acknowledge signal. Then SCLK is to be held low by the microcontroller until a high to low transition on DOUT indicates the end of the conversion.

This signal can be used to create an interrupt in the microcontroller. The microcontroller may now read out the 16-Bit word by giving another 17 clocks on the SCLK pin. It is possible to interrupt the data read-out sequence with a hold of the SCLK signal. **It is important to always read out the last conversion result before starting a new conversion.**

The RESET-sequence is special as its unique pattern is recognized by the module in any state. By consequence it can be used to restart if synchronization between the microcontroller and the MS5536-60C has been lost. This sequence is 21-Bit long. The DOUT signal might change during that sequence (see Fig. 6e). It is recommended to send the RESET sequence before first conversion sequence to avoid hanging up the protocol permanently in case of electrical interference.

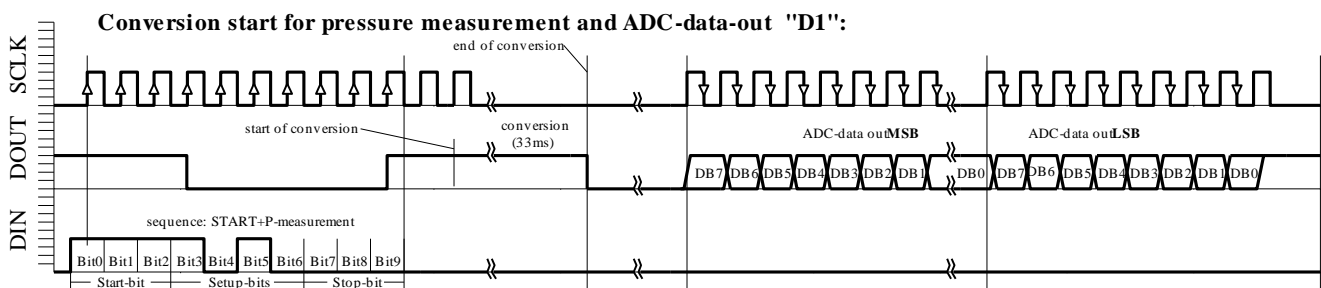

Fig. 6a: D1 ACQUISITION sequence

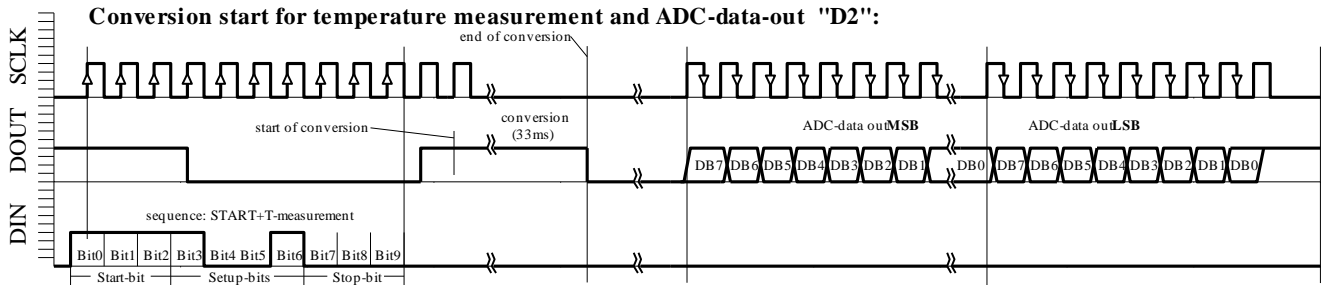

Fig. 6b: D2 ACQUISITION sequence

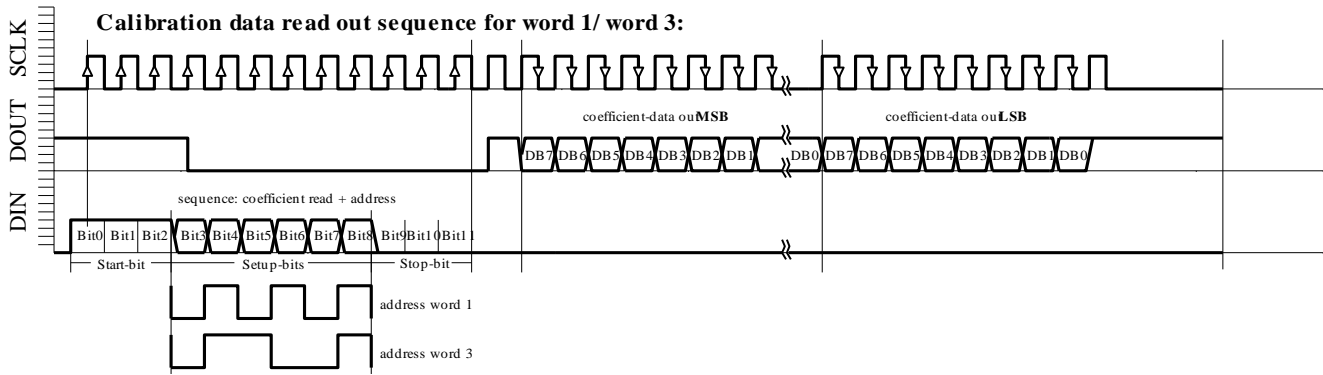

Fig. 6c: Word1, Word3 READING sequence

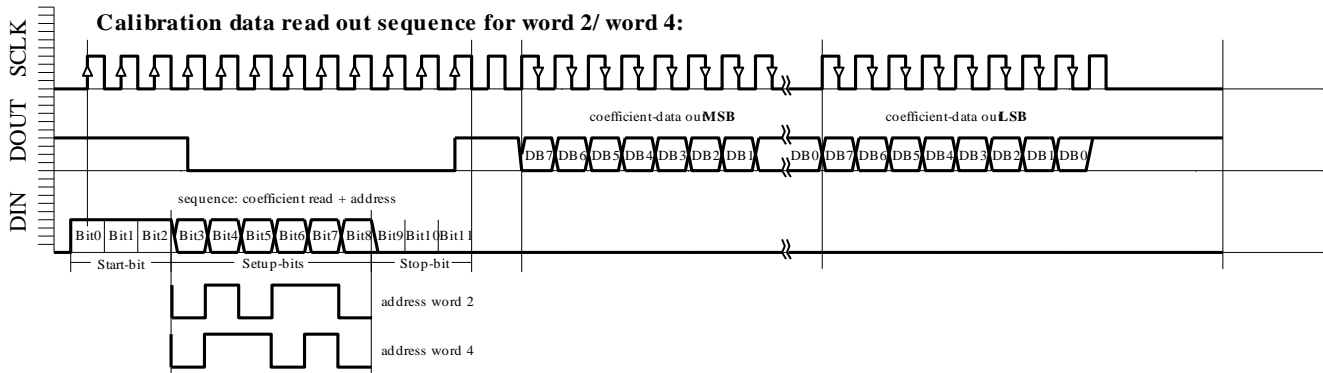

Fig. 6d: W2, W4 READING sequence

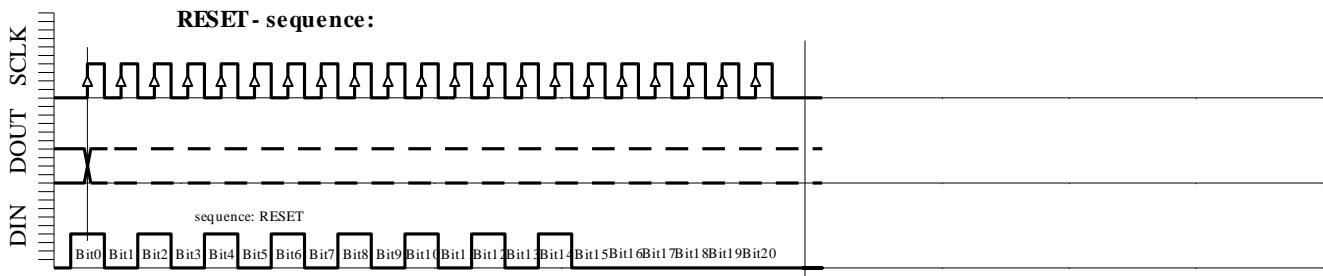

Fig. 6e: RESET sequence (21 bit)

## APPLICATION INFORMATION

### GENERAL

The MS5536-60C consists in a sensor die and a mixed signal interface IC on a single ceramic substrate with Pb-free leads attached. It is compatible with standard PCB-assembly technologies (Pick and Place followed by IR-reflow soldering). Single sided PCB layout is possible. The device directly interfaces to a standard microcontroller, no costly external components like Instrumentation Amplifiers or A/D converters are required. A mark on the ceramic substrate indicates pin 1 (see Fig. 2).

The silicon pressure transducer, the IC and the bonding wires are protected against humidity by a silicone gel and against mechanical damage by a plastic cap. The cap is also used as the pressure port. The MS5536-60C does not show pressure hysteresis effects.

The simple digital 3 wire synchronous serial interface eliminates all sensitive analogue signal lines on the PCB with their often critical routing and guarding issues. The protocol does not require specific interface cells and can be implemented on any microcontroller using standard I/Os. The required external clock-signal of 32.768 kHz is standard in the watch industry and readily available in most hand-held applications.

The MS5536-60C is well suited for battery powered portable devices. This is due to the low supply voltage of 2.2V and the small amount of computing power required to calculate the compensated values for pressure and temperature (use of 4-Bit microcontrollers is possible). No costly end-of-line calibrations are required as the MS5536-60C contains factory stored calibration coefficients.

In order to further enhance accuracy it is recommended to periodically recalibrate the device offset in the application software. This can be achieved by reading the compensated pressure in a known state, preferably at  $\Delta p=0$  (e.g. Blood Pressure Meters with vent open). The detected difference between displayed and actual pressure can be memorized and subtracted from following readings.

The pressure range and port configurations make the MS5536-60C well suited for applications like blood-pressure metering, air flow and pressure measurements in HVAC-systems and liquid level detection.

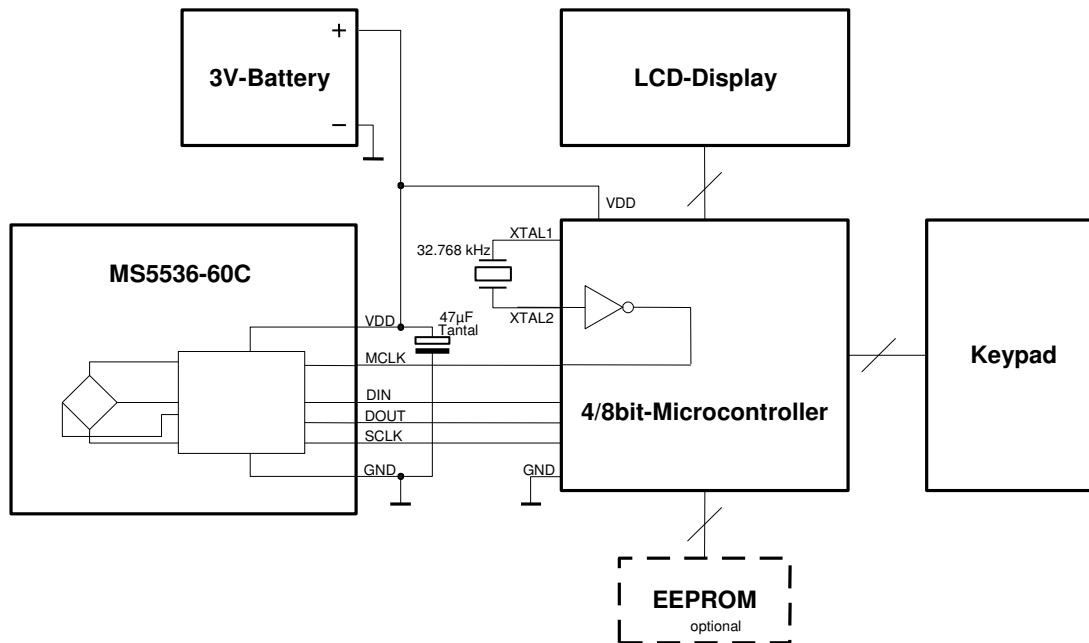
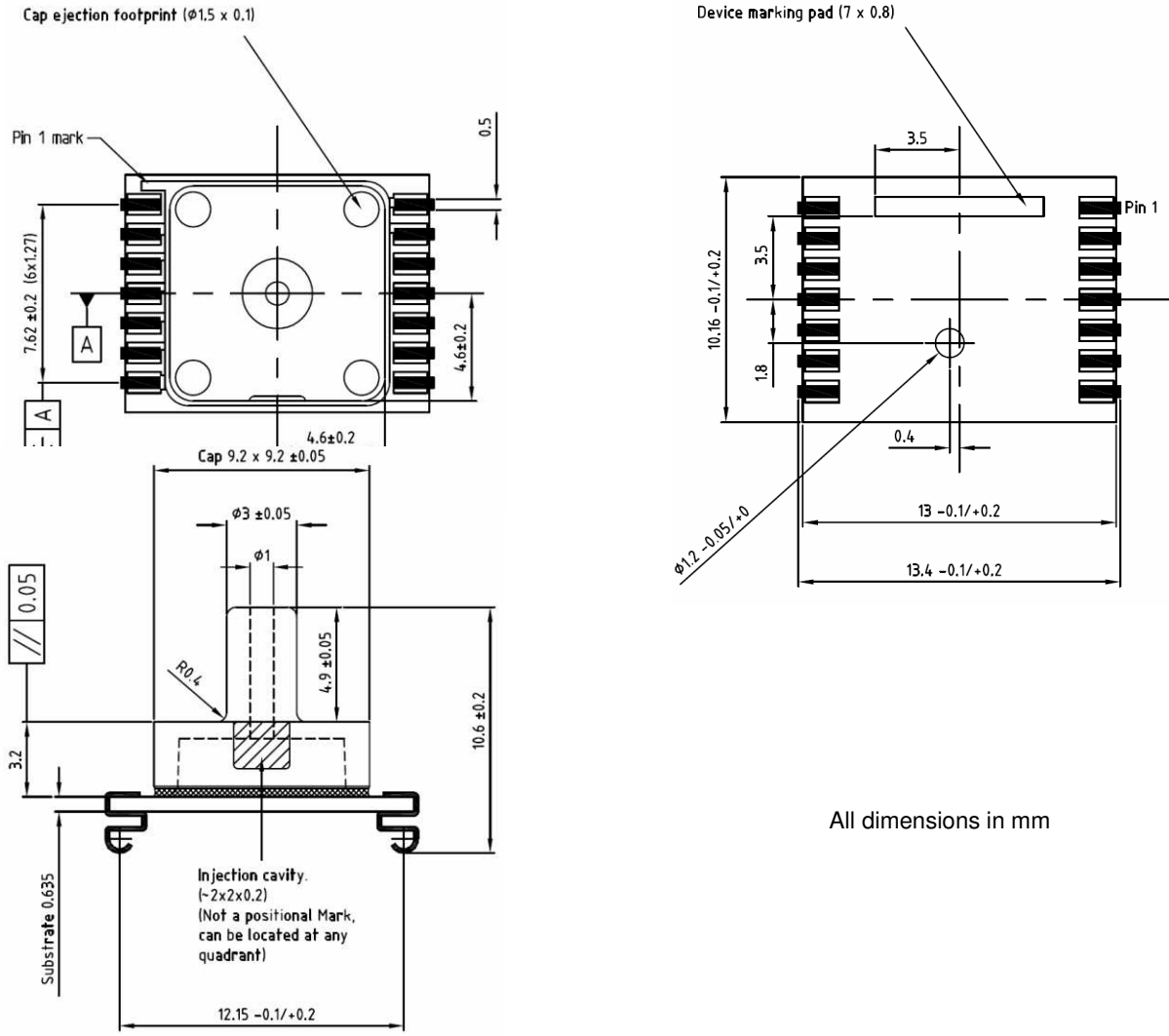

Fig. 7: Application example of the MS5536-60C for a battery powered device

**DEVICE PACKAGE OUTLINES**



All dimensions in mm

Fig. 8: Device package outlines of MS5536-60C-CPJU

**PAD LAYOUT FOR MS5536-60CPJU**

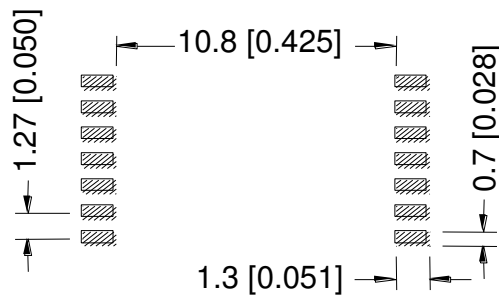

All dimensions in mm [inch]

Fig. 9: recommended pad-layout for MS5536-60C-CPJU / MS5536-60C-CNJU



## ASSEMBLY

### DECOUPLING CAPACITOR

Particular care must be taken when connecting the device to power supply. A 47  $\mu$ F tantalum capacitor must be placed as close as possible of the MS5536-60C's VDD pin. This capacitor will stabilise the power supply during data conversion and thus, provide the highest possible accuracy.

### SOLDERING

Please refer to the application note AN808 for all soldering issues.

### MOUNTING

The MS5536-60C can be placed with automatic Pick&Place equipment using a special vacuum nozzle. It will not be damaged by the vacuum.

For a good mechanical stability, it is important to solder all contact pads. The Pins PEN and PV must be left open or connected to Vdd. **Do not connect to GND!**

### LIGHT SENSITIVITY

The MS5536-60C is protected against sunlight by the cap on front side. It is, however, important to note that the sensor may still be slightly sensitive to sunlight, especially to infrared light sources (Light may also enter the negative pressure port on backside). This is due to the strong photo effect of silicon. As the effect is reversible there will be no damage, but the user has to take care that in the final product the sensor cannot be exposed to direct light during operation. This can be achieved for instance by placing mechanical parts with holes in such that light cannot pass.

### CONNECTING THE PRESSURE PORT

The best connection to the pressure port is achieved with a flexible tube fitted to the full length of the nozzle. Care should be taken to keep the nozzle clean. The tube should be flexible enough to minimize the mechanical stress on the module (see Fig. 10)

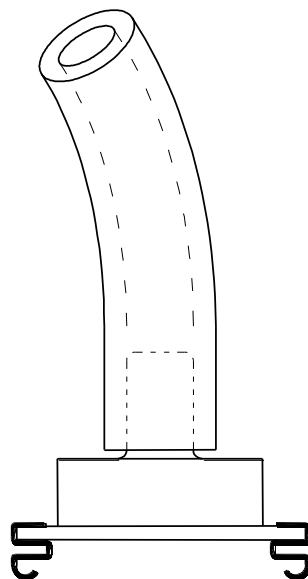

Fig. 10: connection to pressure port

**CLEANING**

The MS5536-60C has been manufactured under cleanroom conditions. It is therefore recommended to assemble the sensor under class 10'000 or better conditions. Should this not be possible, it is recommended to protect the sensor opening during assembly from entering particles and dust. To avoid cleaning of the PCB, solder paste of type 'No-Clean' shall be used.

**CLEANING MIGHT DAMAGE THE SENSOR!**

**ESD PRECAUTIONS**

The electrical contact pads are protected against ESD up to 4 kV HBM (human body model). It is therefore essential to ground machines and personal properly during assembly and handling of the device. The MS5536-60C is shipped in antistatic transport boxes. Any test adapters or production transport boxes used during the assembly of the sensor shall be of an equivalent antistatic material.

**ORDERING INFORMATION**

Product Code	Product	Art. No	Package	Comments
MS5536-60CPJU	60 mbar SMD Gage Pressure Module RoHS	325536010	Gage with plastic cap, upright nozzle, and vent hole on backside, J-Lead type	

**NORTH AMERICA**

Measurement Specialties, Inc.,  
a TE Connectivity Company  
45738 Northport Loop West  
Fremont, CA 94538  
Tel: +1 800 767 1888  
Fax: +1 510 498 1578  
e-mail: pfg.cs.amer@meas-spec.com  
Website: www.meas-spec.com

**EUROPE**

Measurement Specialties (Europe), Ltd.,  
a TE Connectivity Company  
Switzerland Sàrl  
Ch. Chapons-des-Prés 11  
CH-2022 Bevaix  
Tel: +41 32 847 9550  
Fax: + 41 32 847 9569  
e-mail: sales.ch@meas-spec.com  
Website: www.meas-spec.com

**ASIA**

Measurement Specialties (China), Ltd.,  
a TE Connectivity Company  
No. 26 Langshan Road  
Shenzhen High-Tech Park (North) Nanshan  
District, Shenzhen, 518057 China  
Tel: +86 755 3330 5088  
Fax: +86 755 3330 5099  
e-mail: pfg.cs.asia@meas-spec.com  
Website: www.meas-spec.com

**TE.com/sensorsolutions**

Measurement Specialties, Inc., a TE Connectivity company.

Measurement Specialties, TE Connectivity, TE Connectivity (logo) and EVERY CONNECTION COUNTS are trademarks. All other logos, products and/or company names referred to herein might be trademarks of their respective owners.

The information given herein, including drawings, illustrations and schematics which are intended for illustration purposes only, is believed to be reliable. However, TE Connectivity makes no warranties as to its accuracy or completeness and disclaims any liability in connection with its use. TE Connectivity's obligations shall only be as set forth in TE Connectivity's Standard Terms and Conditions of Sale for this product and in no case will TE Connectivity be liable for any incidental, indirect or consequential damages arising out of the sale, resale, use or misuse of the product. Users of TE Connectivity products should make their own evaluation to determine the suitability of each such product for the specific application.

© 2015 TE Connectivity Ltd. family of companies All Rights Reserved.

DA5536-60C\_007

0005536C1246 ECN1740