

SERIES 835 PROCESS-RATED CLASS 150 WAFER-SPHERE® HIGH-PERFORMANCE BUTTERFLY VALVES

Series 835 process-rated ANSI Class 150 high-performance *Wafer-Sphere* butterfly valves are an excellent cost-effective alternative for shutoff pressures up to 100 psi (6.9 bar). The Series 835 provides the same long-lasting tight shutoff capability, excellent flow characteristics, and long service life as the fully ANSI-rated series 815. They are available in 30" – 60" (DN 750 – 1500) designs.

The Series 835 *Wafer-Sphere* butterfly valve is available with trim materials and seat combinations to fit a wide variety of applications from water to abrasives and from air to steam. Valves in this bulletin meet NACE MR0103 requirements when equipped with 17-4 PH shafts. Optionally available are valves specifically prepared for oxygen or high-vacuum service and valves conforming to the European Pressure Equipment Directive 97/23/EC requirements.

FEATURES

Field-Proven Single-Piece Flexible Seat Design

- No additional o-rings or metal parts required to maintain tightness.
- Tight shut-off in either direction (MSS-SP61).
- Lip-seal design compensates for temperature and pressure changes.
- Longer service life with less maintenance.

Offset Shaft And Eccentric Disc

- No seat/disc contact in the open or intermediate position.
- Eliminates wear points at top and bottom of seats for higher cycle life.
- Lowers torque requirements

Fire-Tested Version Available

- Fire-Tite® *Wafer-Sphere* valves have been tested to API 607 and ISO-10497.

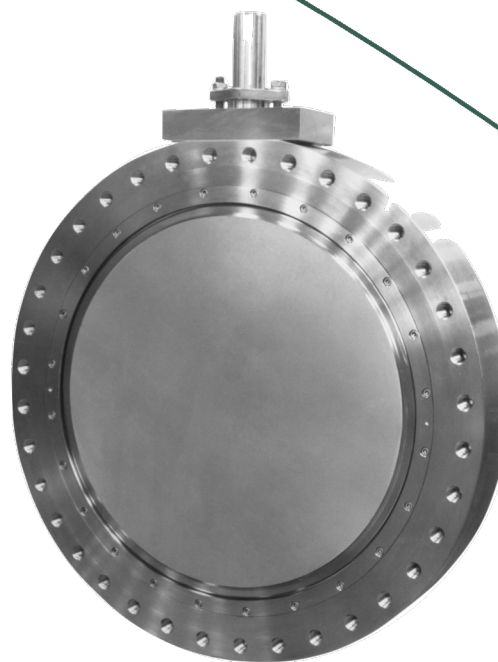

Positive Shaft Retention

- Valves are equipped with a retaining ring at the top of the shaft.

Easy Seat Maintenance

- Simply remove body insert and replace seat. Disassembly of disc and shaft is not required.

Excellent for Both On-Off & Control Applications

- Superior control characteristics
- Inherent flow characteristic is modified equal percentage.
- Wide rangeability
- Tight shut-off even in control applications
- Series 835 valves are suitable for bi-directional dead-end service at the full pressure-temperature rating of the valve.

Single-Source Responsibility

- Purchase valves, actuators, and accessories, completely mounted, from one source.
- Available with electric, manual gear, and pneumatic double-acting or spring-return actuators and a variety of accessories including limit switches and solenoids.

SPECIFICATIONS

Seat Ratings

Seat ratings shown in the charts are based on differential pressure with the disc in the fully closed position and refer to seats only. Maximum body working pressures and test pressure for different materials are shown in the **Valve Body Ratings** table below.

The seat ratings provide a conservative guide for general service. Please consult factory if you have an application specific question.

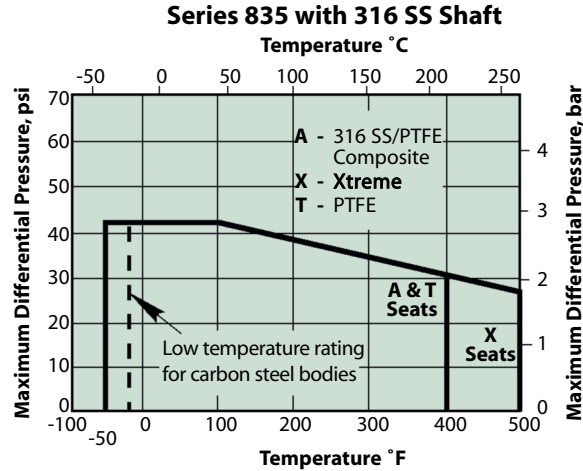
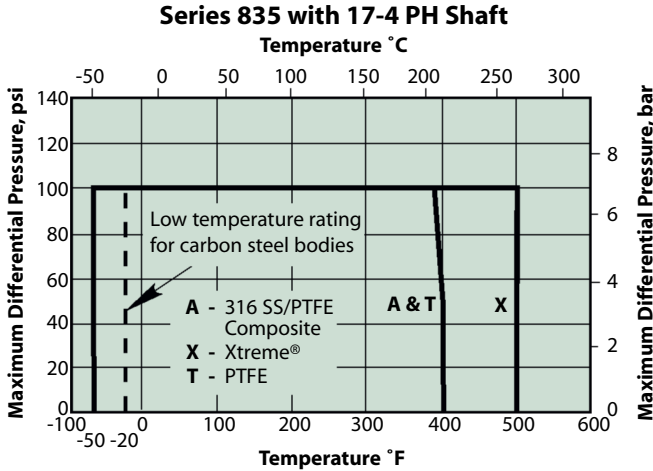

Flow Data

The table below provides flow coefficients for Series 835 valves covered in this bulletin. The Cv values represent the flow of water at 60°F through the valve in U.S. gallons per minute at a pressure drop of 1 psi. The metric equivalent, Kv, is the flow of water at 16°C through the valve in cubic meters per hour at a pressure drop of 1 kg/cm². To convert Cv to Kv, multiply by 0.8569.

Valve Size		Cv
inches	DN	
30	750	44,000
36	900	78,000
40	1000	93,000
42	1050	102,000
48	1200	137,000
54	1350	181,000
60	1500	219,000

Valve Body Ratings

Below are maximum working pressure ratings of the **valve body only** (per ANSI B16.34). The seat ratings above determine the practical pressure limitations according to actual service conditions.

Temperature °F	Pressure – psi	
	Carbon Steel	316 Stainless Steel
-20 to 100	285	275
200	260	240
300	230	215
400	200	195
500	170	170

Temperature °C	Pressure – bar	
	Carbon Steel	316 Stainless Steel
-28.9 to 37.8	19.7	19.0
93.3	17.9	16.6
148.9	15.9	14.8
204.4	13.8	13.4
260.0	11.7	11.7

STANDARDS AND SPECIFICATIONS

ANSI B16.34	Valves – Flanged, Threaded, and Welding End	MSS SP-44	Steel Pipeline Flanges
ANSI B31.1	Power Piping	MSS SP-55	Quality Standard for Steel Castings – Visual Method
ANSI B31.3	Chemical Plant and Petroleum Refinery Piping	MSS SP-68	High Pressure Offset Seat Butterfly Valves
ASME/ANSI B31.4	Liquid Transportation Systems for Hydrocarbons (Liquid Petroleum Gas), Anhydrous Ammonia, and Alcohols	API 598	Valve Inspection and Test
ANSI B31.8	Gas Transmission and Distribution Piping Systems	API 600	Steel Gate Valves (Wall thickness Requirement)
ANS/FCI 70-2	Control Valve Seat Leakage	API 609	Butterfly Valves – Lug-Type and Wafer-Type
BS 6755-Part 2 Appendix A	Specification for Fire-Type-Testing Requirements	NACE Standard MR0103	Materials Resistant to Sulfide Stress Cracking in Corrosive Petroleum Refining Environments.
MSS SP-25	Standard Marking System for Valves		

ANSI – American National Standards Institute
 API – American Petroleum Institute
 ASME – American Society of Mechanical Engineers

NACE – National Association of Corrosion Engineers
 MSS – Manufacturers Standardization Society

SEAT DESIGNS

Standard Seats

The Jamesbury® standard seat design, constructed of PTFE, Xtreme®, or UHMW Polyethylene, or *Xtreme* material, utilizes a flexible lip which will always attempt to return to its original shape and maintain a seal against the disc regardless of flow direction.

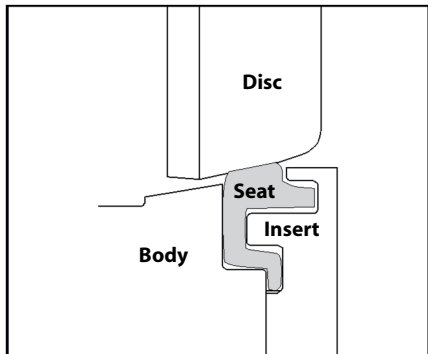

When the valve is shut, the disc slightly deflects the seat. This slight deflection “energizes” the seat. While energized, the sealing surface of the seat is constantly pushing against the edge of the disc.

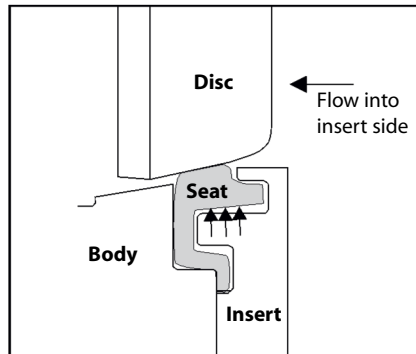

When pressure is on the insert side, pressure is applied under the seat lip. This further amplifies the sealing force between the disc and the seat.

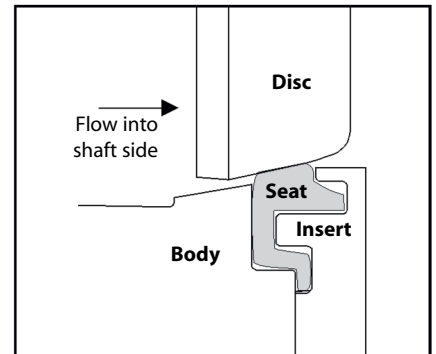

When pressure is on the non-insert side, the disc moves into the seat. Due to the spherical profile of the disc, the more the disc moves into the seat, the tighter the shut-off. Excessive movement of the seat is limited by the flexible lip which contacts the bottom of the groove in the insert ring.

Seat Tightness

ANSI/FCI 70-2 establishes a series of six leakage classes for control valves and defines the test procedure. Class VI allows the least leakage. *Wafer-Sphere* High Performance Butterfly Valves are bubble-tight, MSS-SP61, which would exceed Class VI requirements.

Fire-Tite Seats

The *Fire-Tite* seat was developed for applications where effective shut-off during a fire is a concern. The primary sealing element is PTFE with a back-up metal seat ring. In the event that the PTFE is destroyed, the secondary metal seat provides effective shut-off. The *Fire-Tite* seat is also ideal for critical or severe service applications.

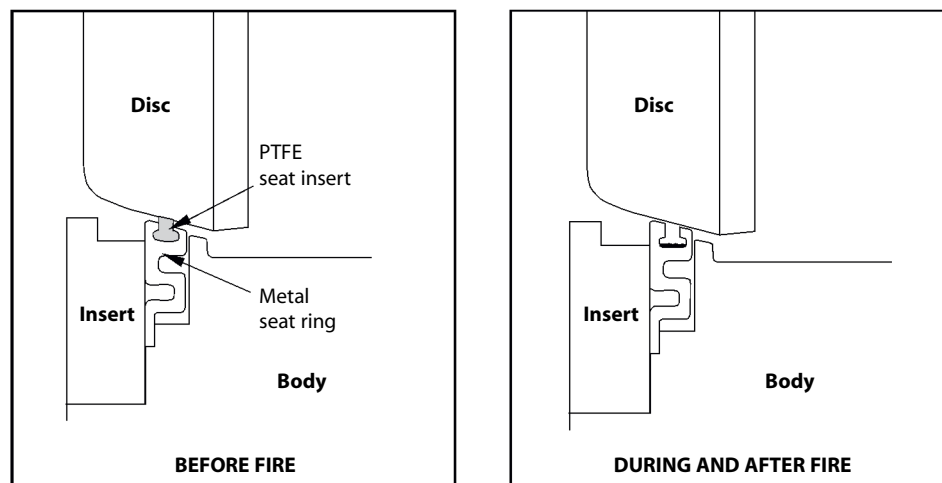

Wafer-Sphere butterfly valves with *Fire-Tite* seats have been tested and approved to API 607 Edition 4 and to BS6755 part 2.

DIMENSIONS

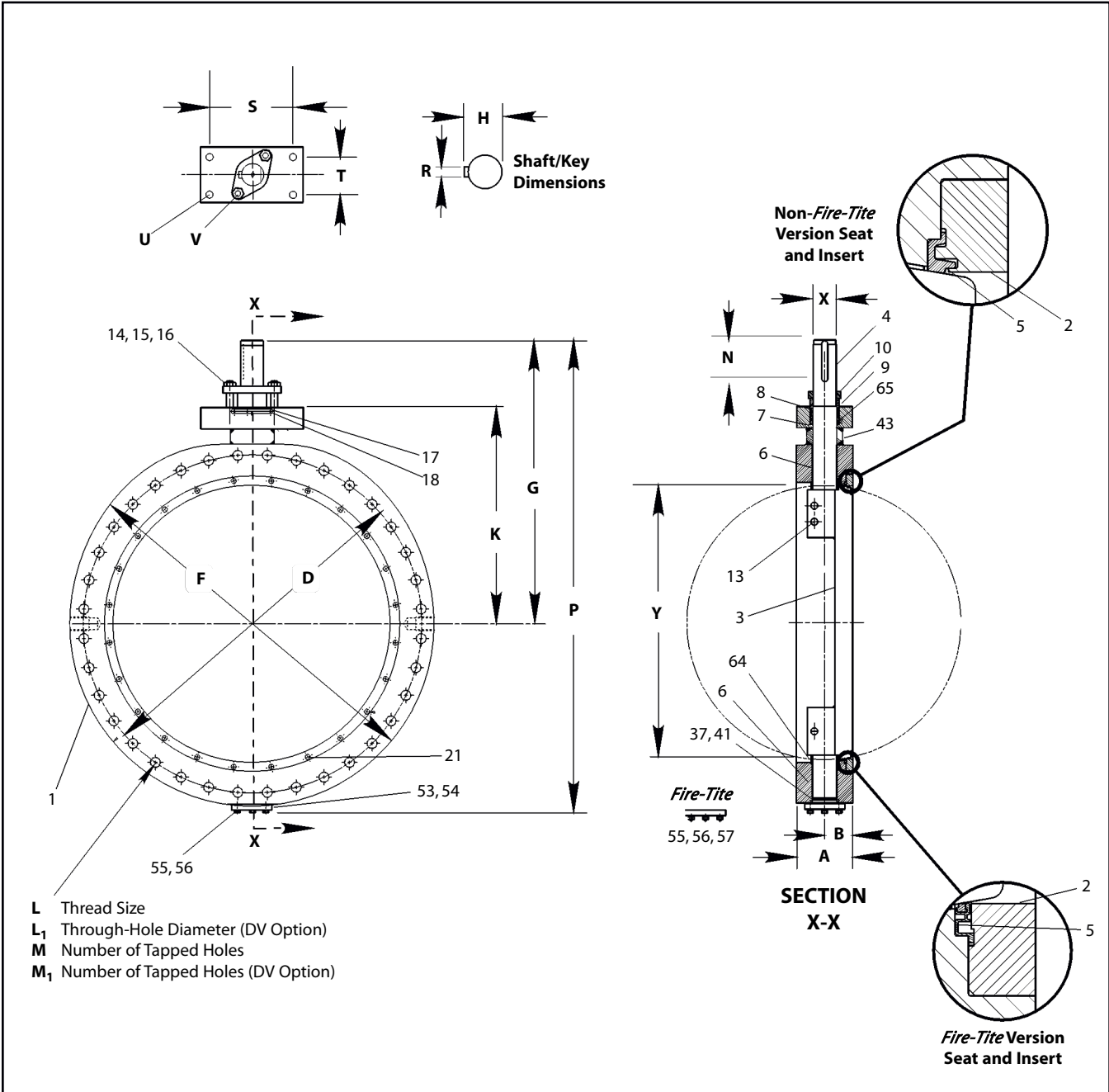

DIMENSIONS

Valve Size inches	Approximate Dimension – inches (Continued below)										
	A*	B	C	D	E	F	G	H	K	L	M
30	4.75	2.67	33.75	36.00	27.70	38.75	30.63	2.39	23.50	1-1/4 – 8	28
36	5.88	3.13	40.25	42.75	34.88	46.00	34.88	2.39	27.75	1-1/2 – 8	32
40	8.25	4.53	44.25	47.25	38.43	50.75	41.06	3.73	31.21	1-1/2 – 8	36
42	8.25	4.13	47.00	49.50	40.00	53.00	41.96	3.73	32.13	1-1/2 – 8	36
48	9.00	5.13	53.50	56.00	46.00	59.50	46.84	3.73	37.00	1-1/2 – 8	44
54	10.00	5.25	59.50	62.75	52.31	66.25	53.25	4.58	40.25	1-3/4 – 8	44
60	10.38	5.31	66.00	69.25	57.90	73.00	56.75	4.58	43.75	1-3/4 – 8	52

* Dimension A shown as standard. Other lengths available on application.

Valve Size inches	Approximate Dimension – inches (Continued above)											Approx. Weight, lb
	L ₁ †	M ₁ †	N	P	R	S	T	U	V	X	Y	
30	1-3/8	4 Tapped (L) 24 Thru (L1)	3.70	51.00	0.50	6.30	2.17	3/4 – 10 UNC	5/8 – 11 UNC	2.17	28.00	1200
36	1-5/8	4 Tapped (L) 28 Thru (L1)	3.70	58.75	0.50	6.30	2.17	3/4 – 10 UNC	7/8 – 9 UNC	2.17	35.00	2000
40	1-5/8	4 Tapped (L) 32 Thru (L1)	5.71	67.56	0.88	9.06	3.54	1 – 8 UNC	1 – 8 UNC	3.35	39.17	3050
42	1-5/8	4 Tapped (L) 32 Thru (L1)	5.71	69.75	0.88	9.06	3.54	1 – 8 UNC	1 – 8 UNC	3.35	40.50	3320
48	1-5/8	4 Tapped (L) 40 Thru (L1)	5.71	78.50	0.88	9.06	3.54	1 – 8 UNC	1 – 8 UNC	3.35	46.50	4200
54	1-7/8	4 Tapped (L) 40 Thru (L1)	6.97	88.37	1.00	13.00	4.72	1-1/4 – 7 UNC	1 – 8 UNC	4.13	52.50	6520
60	1-7/8	4 Tapped (L) 48 Thru (L1)	6.97	95.06	1.00	13.00	4.72	1-1/4 – 7 UNC	1-1/8 – 8 UNC	4.13	58.50	8300

Valve Size DN	Approximate Dimension – mm (Continued below)										
	A*	B	C	D	E	F	G	H	K	L	M
750	121	68	857	914	704	984	778	61	597	1-1/4 – 8	28
900	149	79	1022	1086	886	1168	886	61	705	1-1/2 – 8	32
1000	210	115	1124	1200	976	1290	1043	95	793	1-1/2 – 8	36
1050	210	105	1194	1257	1016	1346	1066	95	816	1-1/2 – 8	36
1200	229	130	1359	1422	1168	1511	1190	95	940	1-1/2 – 8	44
1350	254	133	1511	1594	1329	1683	1353	116	1022	1-3/4 – 8	44
1500	264	135	1676	1759	1471	1854	1441	116	1111	1-3/4 – 8	52

Valve Size DN	Approximate Dimension – mm (Continued above)											Approx. Weight, kg
	L ₁ †	M ₁ †	N	P	R	S	T	U	V	X	Y	
750	1-3/8	4 Tapped (L) 24 Thru (L1)	94	1295	13	160	55	3/4 – 10 UNC	5/8 – 11 UNC	55	711	544
900	1-5/8	4 Tapped (L) 28 Thru (L1)	94	1492	13	160	55	3/4 – 10 UNC	7/8 – 9 UNC	55	889	907
1000	1-5/8	4 Tapped (L) 32 Thru (L1)	145	1716	22	230	90	1 – 8 UNC	1 – 8 UNC	85	995	1383
1050	1-5/8	4 Tapped (L) 32 Thru (L1)	145	1772	22	230	90	1 – 8 UNC	1 – 8 UNC	85	1029	1509
1200	1-5/8	4 Tapped (L) 40 Thru (L1)	145	1994	22	230	90	1 – 8 UNC	1 – 8 UNC	85	1181	1905
1350	1-7/8	4 Tapped (L) 40 Thru (L1)	177	2245	25	330	120	1-1/4 – 7 UNC	1 – 8 UNC	105	1334	2957
1500	1-7/8	4 Tapped (L) 48 Thru (L1)	177	2415	25	330	120	1-1/4 – 7 UNC	1-1/8 – 8 UNC	105	1486	3765

† = "DV" Option only. See **How to Order** Section on last page

OTHER *JAMESBURY* BUTTERFLY VALVES

Please refer to the bulletins listed below for information on other *Jamesbury* high-performance butterfly valves.

ANSI Class 150/300 <i>Wafer-Sphere</i>	W101-6
ANSI Class 600 <i>Wafer-Sphere</i>	W104-1
Cryogenic <i>Wafer-Sphere</i> Valves	W130-1
<i>Wafer-Sphere</i> Valves for Steam Service	W150-1
<i>Wafer-Sphere</i> Valves for Chlorine Service	W150-2
<i>Wafer-Sphere</i> Valves for Oxygen Service	W150-3
<i>Wafer-Sphere</i> Valves for Vacuum Service	W150-4

BILL OF MATERIAL AND PARTS LIST			
Part No.	Part Name	Type 835L-11-22HB 835L-11-2236 83PL-11-22HB 83PL-11-2236 F835L-31-22HB F83PL-31-22HB	Type 835L-11-36HB 835L-11-3600 83PL-11-36HB 83PL-11-3600 F835L-11-36HB F83PL-11-36HB
1	Body	Carbon steel ASTM A216 WCB 30" – 36" Carbon Steel ASTM A105 42" & larger	Stainless steel ASTM A351 CF8M 30" – 36" Stainless Steel ASTM A182 F316L 42" & larger
2	Insert	Carbon steel	Stainless steel
3	Disc	316 Stainless steel	316 Stainless steel
4	Bonnet-End Shaft (Driver)	316 Stainless steel or 17-4PH stainless steel	316 Stainless steel or 17-4PH Stainless steel
5	Seat	See last page (How to Order) for seat codes	
6	Shaft Bearing	PTFE Composite backed with 316 Stainless steel	
7	Spacer	316 Stainless steel	
8	Shaft Seals	Carbon filled enhanced PTFE or graphite (<i>Fire-Tite</i>)	
9	Top Compression Ring 42" – 60" (DN 1050 – 1500) only	Stainless steel	
10	Compression Plate	Stainless steel (1)	
13	Disc Pin	Same as shaft material	
14	Stud	Stainless steel	
15	Hex Jam Nut	Stainless steel	
16	Lockwasher	Stainless steel	
17	Nameplate	Stainless steel	
18	Drive Screw	Stainless steel	
21	Cap Screw	Stainless steel	
26	Nameplate	Stainless steel	
27	Drive Screws	Stainless steel	
37	Non-Bonnet End Shaft (Idle)	316 Stainless steel or 17-4PH Stainless steel	316 Stainless steel or 17-4PH Stainless steel
41	Bottom Bearing Spacer 30" & 42" (DN 750 & 1050)	PTFE	
43	Top Bearing Spacer	PTFE	
53	Cover Plate	Stainless steel (1)	
54	Gasket	PTFE or Graphite (<i>Fire-Tite</i>)	
55	Cap Screw/ Stud	Stainless steel	
56	Lockwasher	Stainless steel	
57	Nut	Stainless steel	
64	Thrust Bearing	Stainless steel	
65	Spacer	Stainless steel	

(1) Carbon Steel for 48" – 60" (DN 1200 – 1500) carbon steel valves.

VALVE TORQUE DATA

The torque required to open or close the Series 835 can easily be calculated using the equation below. However, for your convenience, the following tables can be used as a quick guide for actuator selection. If the valve's torque is not listed in the tables, **use the equation to calculate the torque**. Refer to bulletins for specific pneumatic and electric actuators. Select an actuator that provides the same or greater torque output than the valve's torque. **If in doubt, select the next larger actuator.**

Valve Size inches	Torque at Given Shut-Off Differential Pressure for Series 835 Valves with PTFE (T) or <i>Xtreme</i> (X) Seat with Shaft Downstream or Upstream				
	FT•LBS @ 20 psi	FT•LBS @ 40 psi	FT•LBS @ 60 psi	FT•LBS @ 80 psi	FT•LBS @ 100 psi
30	1600	1790	1990	2180	2380
36	2460	2810	3170	3530	3890
40	3340	3780	4220	4660	5100
42	3920	4440	4960	5480	6000
48	6170	6940	7710	8480	9250
54	9100	10200	11300	12400	13500
60	13500	15000	16500	18000	19500

Valve Size DN	Torque at Given Shut-Off Differential Pressure for Series 835 Valves with PTFE (T) or <i>Xtreme</i> (X) Seat with Shaft Downstream or Upstream				
	N•m @ 1.4 bar	N•m @ 2.8 bar	N•m @ 4.1 bar	N•m @ 5.5 bar	N•m @ 6.9 bar
750	2170	2430	2700	2960	3230
900	3335	3810	4300	4790	5275
1000	4530	5125	5720	6320	6915
1050	5315	6020	6725	7430	8135
1200	8365	9410	10460	11500	12540
1350	12340	13830	15320	16810	18300
1500	18300	20340	22370	24400	26440

Valve Size inches	Torque at Given Shut-Off Differential Pressure for Series F835 Valves with <i>Fire-Tite</i> Seat with Shaft Downstream or Upstream				
	FT•LBS @ 20 psi	FT•LBS @ 40 psi	FT•LBS @ 60 psi	FT•LBS @ 80 psi	FT•LBS @ 100 psi
30	1790	1970	2160	2340	2530
36	2650	3000	3350	3700	4050
40	3830	4060	4490	4920	5350
42	4310	4820	5330	5840	6350
48	6660	7420	8180	8940	9700
54	9680	10760	11840	12900	14000
60	14300	15800	17300	18800	20300

Valve Size DN	Torque at Given Shut-Off Differential Pressure for Series F835 Valves with <i>Fire-Tite</i> Seat with Shaft Downstream or Upstream				
	N•m @ 1.4 bar	N•m @ 2.8 bar	N•m @ 4.1 bar	N•m @ 5.5 bar	N•m @ 6.9 bar
750	2430	2670	2930	3175	3430
900	3590	4070	4540	5015	5490
1000	4920	5510	6090	6670	7255
1050	5840	6535	7230	7920	8610
1200	9030	10060	11090	12120	13150

TORQUE EQUATION

Use the following equation to calculate the torque required to open and close the Series 815 and Series 830 valves.

Torque required (FT•LBS) = (Kt multiplied by the shut-off differential pressure in psi) + Ts.

EXAMPLE: 30" (DN 750) 835L-11-36HBMT at 70 psi (4.8 bar) differential pressure = (9.8 X 70) + 1400 = 2066 FT•LBS.

To convert FT•LBS to N•m, multiply by 1.356.

Valve Size		Series 835 T, X Seats		Series 835 <i>Fire-Tite</i> Seats	
inches	DN	Kt Shaft Downstream or Upstream	Ts	Kt Shaft Downstream or Upstream	Ts
30	750	9.8	1400	9.3	1600
36	900	17.9	2100	17.5	2300
40	1000	22	2900	21.5	3200
42	1050	26	3400	25.5	3800
48	1200	38.5	5400	38	5900
54	1350	54.9	8000	54	8600
60	1500	75.1	12000	74.5	12800

HOW TO ORDER TYPE 835 *Wafer-Sphere* VALVE

These *Wafer-Sphere* valves are described by size and a multi-character code that defines body configuration, body, disc, shaft, and seat and seal materials. Explanation of the code for valves in this bulletin is as follows.

1	2	3	4	5	6	7	8	9
48	835	L	—	11	22	HB	XZ	—

Example: The above designates a 48" Series 835 single-flange lugged design valve with carbon steel body, 316 stainless steel disc, 17-4PH shaft, standard *Xtreme* seat and Carbon filled Enhanced PTFE shaft seals.

1	Size					
inches	30	36	42	48	54	60
DN	750	900	1050	1200	1350	1500

2	Valve Type
835	Standard
83P	Standard with CE Marking and Documentation
F835	<i>Fire-Tite</i>
F83P	<i>Fire-Tite</i> with CE Marking and Documentation

3	Body Style
L	Single-Flanged Lugged

4	Special Service
O	Oxygen
HV	High Vacuum
HVC	High Vacuum certified
—	(No entry if standard)

5	Type
11	Standard
31	<i>Fire-Tite</i>

6	Body Material
22	Carbon Steel
36	316 Stainless Steel

7	Disc and Shaft Material
00	Same as body material*
HB	316 Stainless disc, 17-4PH stainless shaft
36	316 Stainless disc and shaft†

* Use with 316 stainless steel body only.

NOTE: 17-4PH shaft required for NACE MR0103 compliance.

† Use with carbon steel body only

8	Seat & Seal Material	
	Seats	Seal
	Standard	
XZ	<i>Xtreme</i>	Carbon Filled Enhanced PTFE
	Optional	
TT	PTFE	PTFE
UU	UHMW Polyethylene	UHMW Polyethylene
	<i>Fire-Tite</i>	
AE	316 SS/PTFE	Graphite
XE	316 SS/ <i>Xtreme</i>	Graphite

9	Modifier Code
—	Standard
DV	Through-Drilled Flange Holes

As the use of the valve is application specific, a number of factors should be taken into account when selecting a valve for a given application. Therefore, some of the applications in which the valves are used are outside the scope of this document. If you have questions concerning the use, application or compatibility of the valve with the intended service, contact Metso Automation for more information.

Subject to change without prior notice.

Metso Automation Inc.

Europe, Levytie 6, P.O. Box 310, 00811 Helsinki, Finland.
Tel. +358 20 483 150. Fax +358 20 483 151

North America, 44 Bowditch Drive, P.O. Box 8044, Shrewsbury, MA 01545, USA.
Tel. +1 508 852 0200. Fax +1 508 852 8172

Europe, 6-8 rue du Maine, 68271 Wittenheim Cedex, France.
Tel. +33 (0)3 89 50 64 00. Fax +33 (0)3 89 50 64 40

South America, Av. Independência, 2500- Iporanga, 18087-101, Sorocaba-São Paulo Brazil. Tel. +55 15 2102 9700. Fax +55 15 2102 9748/49

Asia Pacific, 238A Thomson Road, #25-09 Novena Square Tower A, 307684 Singapore.
Tel. +65 6511 1011. Fax +65 6250 0830

China, 19/F, the Exchange Beijing, No. 118, Jianguo Lu Yi, Chaoyang Dist, 100022 Beijing, China.
Tel. +86-10-6566-6600. Fax +86-10-6566-2575

Middle East, Roundabout 8, Unit AB-07, P.O. Box 17175, Jebel Ali Freezone, Dubai, United Arab Emirates. Tel. +971 4 883 6974. Fax +971 4 883 6836

www.metso.com/automation

