



# User Manual for RCC Series Controllers

RCC972  
RCC1410  
RCC2414  
RCC8842

MAN1078-06-EN\_RCC\_Series\_UserManual

## PREFACE

This manual explains how to use the RCC Controller.

Copyright© 2017 Horner APG, LLC, 59 South State Avenue, Indianapolis, Indiana 46201. All rights reserved. No part of this publication may be reproduced, transmitted, transcribed, stored in a retrieval system, or translated into any language or computer language, in any form by any means, electronic, mechanical, magnetic, optical, chemical, manual or otherwise, without the prior agreement and written permission of Horner APG, Inc.

All software described in this document or media is also copyrighted material subject to the terms and conditions of the Horner Software License Agreement.

Information in this document is subject to change without notice and does not represent a commitment on the part of Horner APG.

Ethernet™ is a trademark of Xerox Corporation.  
microSD™ and CompactFlash are registered trademarks of SanDisk Corporation.

### **For user manual updates, contact Technical Support:**

#### **North America:**

Tel: (+) 1-877-665-5666

Fax: (+) (317) 639-4279

Website: <https://hornerautomation.com>

Email: [techsppt@heapg.com](mailto:techsppt@heapg.com)

#### **Europe:**

Tel: (+) 353-21-4321-266

Fax: (+) 353-21-4321-826

Website: <http://www.horner-apg.com>

Email: [technical.support@horner-apg.com](mailto:technical.support@horner-apg.com)

## LIMITED WARRANTY AND LIMITATION OF LIABILITY

Horner APG, LLC, ("HE-APG") warrants to the original purchaser that the RCC controller module manufactured by HE-APG is free from defects in material and workmanship under normal use and service. The obligation of HE-APG under this warranty shall be limited to the repair or exchange of any part or parts which may prove defective under normal use and service within two (2) years from the date of manufacture or eighteen (18) months from the date of installation by the original purchaser whichever occurs first, such defect to be disclosed to the satisfaction of HE-APG after examination by HE-APG of the allegedly defective part or parts. THIS WARRANTY IS EXPRESSLY IN LIEU OF ALL OTHER WARRANTIES EXPRESSED OR IMPLIED INCLUDING THE WARRANTIES OF MERCHANTABILITY AND FITNESS FOR USE AND OF ALL OTHER OBLIGATIONS OR LIABILITIES AND HE-APG NEITHER ASSUMES, NOR AUTHORIZES ANY OTHER PERSON TO ASSUME FOR HE-APG, ANY OTHER LIABILITY IN CONNECTION WITH THE SALE OF THIS RCC module. THIS WARRANTY SHALL NOT APPLY TO THIS RCC module OR ANY PART THEREOF WHICH HAS BEEN SUBJECT TO ACCIDENT, NEGLIGENCE, ALTERATION, ABUSE, OR MISUSE. HE-APG MAKES NO WARRANTY WHATSOEVER IN RESPECT TO ACCESSORIES OR PARTS NOT SUPPLIED BY HE-APG. THE TERM "ORIGINAL PURCHASER", AS USED IN THIS WARRANTY, SHALL BE DEEMED TO MEAN THAT PERSON FOR WHOM THE RCC module IS ORIGINALLY INSTALLED. THIS WARRANTY SHALL APPLY ONLY WITHIN THE BOUNDARIES OF THE CONTINENTAL UNITED STATES.

In no event, whether as a result of breach of contract, warranty, tort (including negligence) or otherwise, shall HE-APG or its suppliers be liable of any special, consequential, incidental or penal damages including, but not limited to, loss of profit or revenues, loss of use of the products or any associated equipment, damage to associated equipment, cost of capital, cost of substitute products, facilities, services or replacement power, down time costs, or claims of original purchaser's customers for such damages.

**To obtain warranty service, return the product to your distributor with a description of the problem, proof of purchase, postpaid, insured and in a suitable package.**

## ABOUT PROGRAMMING EXAMPLES

Any example programs and program segments in this manual or provided on accompanying diskettes are included solely for illustrative purposes. Due to the many variables and requirements associated with any particular installation, Horner APG cannot assume responsibility or liability for actual use based on the examples and diagrams. It is the sole responsibility of the system designer utilizing the RCC controller module to appropriately design the end system, to appropriately integrate the RCC controller module and to make safety provisions for the end equipment as is usual and customary in industrial applications as defined in any codes or standards which apply.

**NOTE: The programming examples shown in this manual are for illustrative purposes only. Proper machine operation is the sole responsibility of the system integrator.**

## VISUAL MAP OF KEY CHAPTERS

FIRST STEP of ANY TASK: DATASHEET			
<p>Each RCC unit is sent with a datasheet in the box. <b>The datasheet is the first document to refer to for model-specific information related to RCC models such as pin-outs, jumper settings, and other key installation information.</b> To obtain updates to datasheets, manuals and user documentation, visit a Horner website</p> <p>North America      <a href="https://hornerautomation.com">https://hornerautomation.com</a>            Europe              <a href="http://www.horner-apg.com">http://www.horner-apg.com</a></p>			
QUICK START	INSTALLATION	PROGRAMMING	TROUBLESHOOTING
<a href="#">Safety / Compliance</a>	<a href="#">Safety / Compliance</a>	<a href="#">Safety / Compliance</a>	<a href="#">Safety / Compliance</a>
<a href="#">Introduction</a>	<a href="#">Introduction</a>	<a href="#">Introduction</a>	<a href="#">Introduction</a>
	<a href="#">Mechanical Installation</a>	<a href="#">Serial Communications</a>	<a href="#">Fail / Safe</a>
	<a href="#">Electrical Installation</a>	<a href="#">CAN Communications</a>	<a href="#">Maintenance</a>
		<a href="#">Ethernet Communications</a>	<a href="#">Modbus Communication</a>
		<a href="#">Downloadable Communication Protocols</a>	<a href="#">Troubleshooting</a>
		<a href="#">Removable Media</a>	
		<a href="#">General I/O</a>	
		<a href="#">Cscope Configuration</a>	
		<a href="#">Registers</a>	

# TABLE OF CONTENTS

PREFACE .....	2
LIMITED WARRANTY AND LIMITATION OF LIABILITY .....	3
ABOUT PROGRAMMING EXAMPLES.....	3
VISUAL MAP OF KEY CHAPTERS.....	4
TABLE OF CONTENTS .....	5
CHAPTER 1: SAFETY / COMPLIANCE .....	8
1.1 Safety Warnings and Guidelines .....	8
1.2 Grounding.....	9
1.3 Compliance .....	9
CHAPTER 2: INTRODUCTION.....	10
2.1 General Overview of a 972, 1410, or 8842 RCC Unit .....	10
2.2 General Overview of an RCC2414 Unit.....	11
2.3 Connectivity to the RCC .....	12
2.4 Features of RCC.....	13
2.5 Accessories.....	14
2.6 Useful Documents and References.....	14
2.7 Opening Cscape Help File.....	14
CHAPTER 3: MECHANICAL INSTALLATION.....	15
3.1 Overview.....	15
3.2 RCC Dimensions.....	15
CHAPTER 4: ELECTRICAL INSTALLATION .....	17
4.1 Grounding Definition .....	17
4.2 Ground Specifications.....	17
4.3 How to Test for Good Ground .....	18
CHAPTER 5: SERIAL COMMUNICATIONS.....	20
5.1 Overview.....	20
5.2 MJ1 Serial Port Pinout.....	20
5.3 Cscape Programming via Serial Port .....	23
5.4 Ladder-Controlled Serial Communication.....	23
CHAPTER 6: CAN COMMUNICATIONS .....	24
6.1 Overview.....	24
6.2 Port Description.....	24
6.3 CAN Port Wiring.....	25
6.4 Cscape Programming via CAN .....	27
6.5 Ladder-Controlled CAN Communication .....	27
6.6 Using CAN for I/O Expansion (Network I/O).....	27
CHAPTER 7: ETHERNET COMMUNICATION.....	28
7.1 MAC Address .....	28
7.2 Ethernet Module Protocols and Features .....	28
7.3 Ethernet System Requirements .....	28
7.4 Ethernet Module Specifications.....	29
7.5 Ethernet Module Configuration .....	29

- 7.5 Ethernet Configuration - IP Parameters ..... 32
- 7.6 Ethernet Module Protocol Configuration ..... 32
- CHAPTER 8: DOWNLOADABLE COMMUNICATION PROTOCOLS ..... 33
  - 8.1 Overview ..... 33
  - 8.2 Protocol Config ..... 35
  - 8.3 Network Configuration ..... 36
  - 8.4 Device List and Device Configuration ..... 38
  - 8.5 Scan List ..... 40
  - 8.6 Data Mapping Configuration (Scan List Entry) ..... 41
- CHAPTER 9: REMOVABLE MEDIA ..... 43
  - 9.1 Overview ..... 43
  - 9.2 microSD Cards ..... 43
  - 9.3 microSD File System ..... 43
  - 9.4 Using Removable Media to Log Data ..... 44
  - 9.5 Using Removable Media to Load and Save Applications ..... 44
  - 9.6 Removable Media (RM) Function Blocks in Cscope ..... 44
  - 9.7 Filenames used with the Removable Media (RM) Function Blocks ..... 45
  - 9.8 System Registers used with RM ..... 46
- CHAPTER 10: GENERAL I/O ..... 47
  - 10.1 Overview ..... 47
  - 10.2 Solid-State Digital Outputs ..... 47
  - 10.3 Digital Inputs ..... 48
  - 10.4 Analog Inputs ..... 49
  - 10.5 Analog Outputs ..... 49
- CHAPTER 11: CSCAPE CONFIGURATION ..... 50
  - 11.1 Overview ..... 50
  - 11.2 Cscope Status Bar ..... 50
  - 11.3 Establishing Communications ..... 51
  - 11.4 Hardware Configuration ..... 60
  - 11.5 Scaling Analog Inputs ..... 63
- Chapter 12: BACK-UP BATTERY ..... 65
  - 12.1 Overview ..... 65
  - 12.2 Storing Register Contents ..... 65
  - 12.3 Battery Life ..... 65
  - 12.4 Lithium Battery Safety ..... 65
  - 12.6 Battery Charging Status ..... 66
  - 12.7 Battery Charging State ..... 66
  - 12.8 Battery Status in System Registers ..... 66
- CHAPTER 13: REGISTERS ..... 67
  - 13.1 Register Definitions ..... 67
  - 13.2 Useful %S and %SR registers ..... 68
  - 13.3 Resource Limits ..... 77
  - 13.4 Register Map for RCC Series ..... 78
- CHAPTER 14: FAIL-SAFE SYSTEM ..... 79
  - 14.1 Overview ..... 79
  - 14.2 Settings ..... 79
  - 14.3 Backup / Restore Data ..... 80
  - 14.4 AutoLoad ..... 82
  - 14.5 AutoRun ..... 84

CHAPTER 15: MAINTENANCE .....	85
15.1 Firmware Updates.....	85
15.2 Backup Battery.....	85
CHAPTER 16: MODBUS COMMUNICATIONS.....	87
16.1 Modbus Overview .....	87
16.2 Modbus Slave Overview .....	87
16.3 Modbus Master Overview .....	88
16.4 Opening Cscape Help File .....	89
16.5 Modbus Addressing Table for RCC Units.....	90
CHAPTER 17: TROUBLESHOOTING / TECHNICAL SUPPORT.....	91
17.1 LED - Normal Functionality.....	91
17.2 LED Load Program/Firmware Functionality.....	91
17.3 Switch - Normal Functionality .....	92
17.4 LED - Diagnostic Functionality.....	92
17.5 Connecting to the RCC.....	93
17.7 CsCAN Network .....	95
17.8 Removable Media - Basic Troubleshooting .....	96
17.9 Technical Support Contacts .....	96
MAIN INDEX .....	97
INDEX OF FIGURES AND TABLES .....	100

## CHAPTER 1: SAFETY / COMPLIANCE

### 1.1 Safety Warnings and Guidelines

When found on the product, the following symbols specify:



**Warning** - Consult user documentation.



**Warning** - Electrical Shock Hazard.

**WARNING - EXPLOSION HAZARD** - Do not disconnect equipment unless power has been switched off or the area is known to be non-hazardous.

**WARNING** - To avoid the risk of electric shock or burns, always connect the safety (or earth) ground before making any other connections.

**WARNING** - To reduce the risk of fire, electrical shock, or physical injury, it is strongly recommended to fuse the voltage measurement inputs. Be sure to locate fuses as close to the source as possible.

**WARNING** - Replace fuse with the same type and rating to provide protection against risk of fire and shock hazards.

**WARNING** - In the event of repeated failure, do not replace the fuse again as a repeated failure indicates a defective condition that will not clear by replacing the fuse.

**WARNING - EXPLOSION HAZARD** - Substitution of components may impair suitability for Class I, Division 2.

**WARNING** - The USB parts are for operational maintenance only. Do not leave permanently connected unless area is known to be non-hazardous.

**WARNING - EXPLOSION HAZARD - BATTERIES MUST NOT BE CHANGED.**

**WARNING - BATTERY MAY EXPLODE IF MISTREATED. DO NOT RECHARGE, DISSASSEMBLE, OR DISPOSE IN FIRE.**

**WARNING:** Only qualified electrical personnel familiar with the construction and operation of this equipment and the hazards involved should install, adjust, operate, or service this equipment. Read and understand this manual and other applicable manuals in their entirety before proceeding. Failure to observe this precaution could result in severe bodily injury or loss of life.

- a. All applicable codes and standards need to be followed in the installation of this product.
- b. For I/O wiring (discrete), use the following wire type or equivalent: Belden 9918, 18 AWG or larger.



Adhere to the following safety precautions whenever any type of connection is made to the module.

- a. Connect the green safety (earth) ground first before making any other connections.
- b. When connecting to electric circuits or pulse-initiating equipment, open their related breakers. Do not make connections to live power lines.
- c. Make connections to the module first; then connect to the circuit to be monitored.
- d. Route power wires in a safe manner in accordance with good practice and local codes.
- e. Wear proper personal protective equipment including safety glasses and insulated gloves when making connections to power circuits.
- f. Ensure hands, shoes, and floors are dry before making any connection to a power line.
- g. Make sure the unit is turned OFF before making connection to terminals. Make sure all circuits are de-energized before making connections.
- h. Before each use, inspect all cables for breaks or cracks in the insulation. Replace immediately if defective.

## 1.2 Grounding

Grounding is covered in various chapters within this manual.

## 1.3 Compliance

To check for compliance and updates, visit the Horner website.

North America	<a href="https://hornerautomation.com">https://hornerautomation.com</a>
Europe	<a href="http://www.horner-apg.com">http://www.horner-apg.com</a>

## CHAPTER 2: INTRODUCTION

### 2.1 General Overview of a 972, 1410, or 8842 RCC Unit

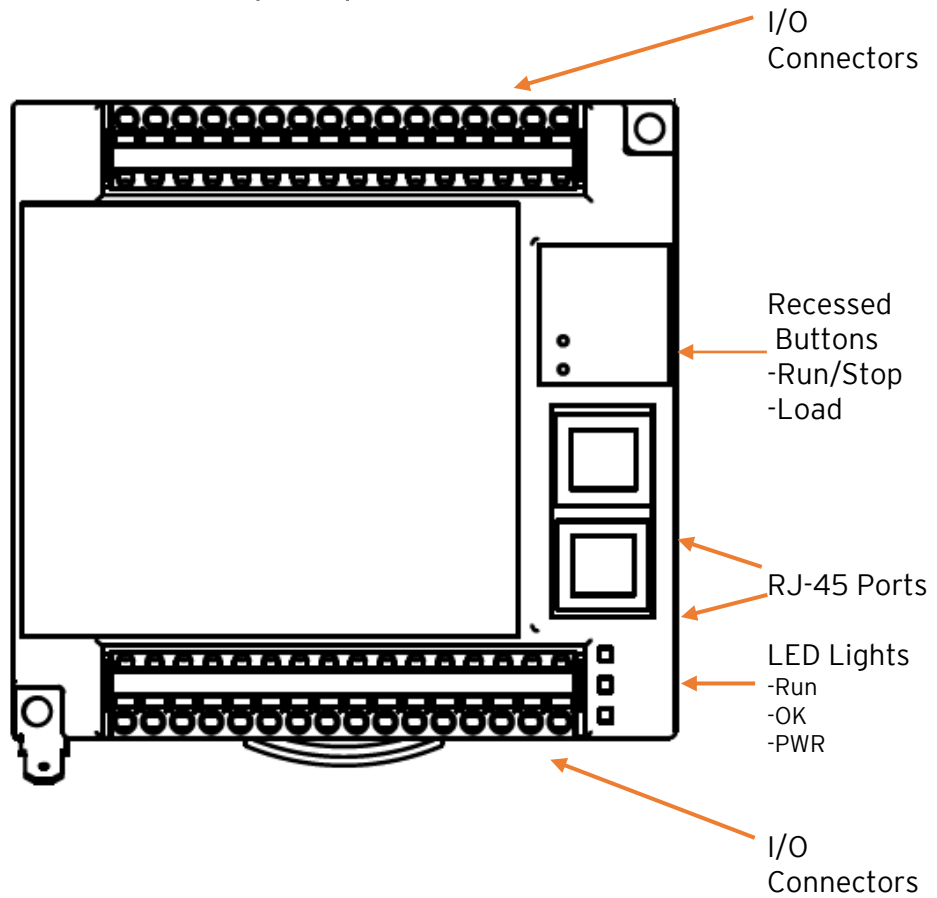
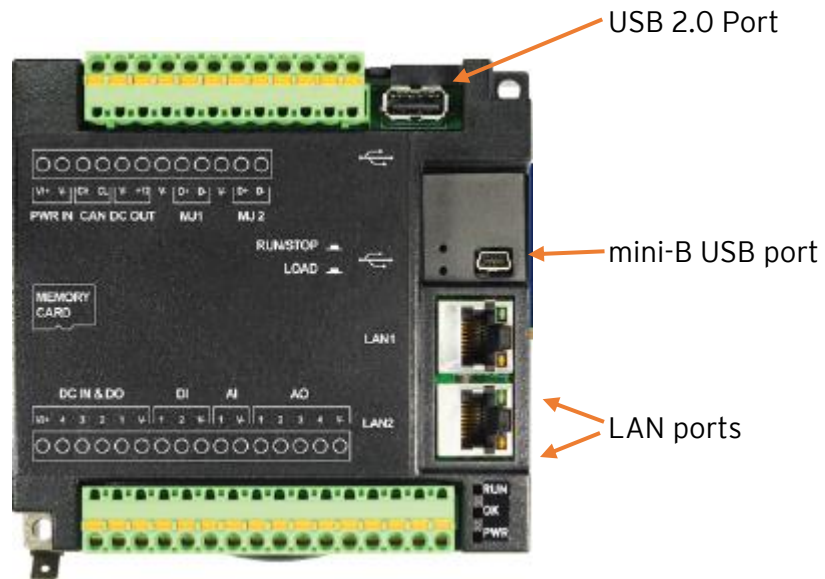

Figure 2.1 - Overview of the RCC

## 2.2 General Overview of an RCC2414 Unit



**NOTE:** See USB precaution in datasheet

### 2.2.1 Where to Find Information about the RCC

- a) **Datasheet** - The datasheet is the first document to refer to for key information related to specific RCC models. The datasheets are available on the Horner website and contain pin-outs and other model specific information.

Table 2.1 - Datasheets for RCC Models	
RCC Model	Datasheet
RCC972	MAN0970
RCC1410	MAN1034
RCC2414	MAN1033
RCC8842	MAN1073

- b) **User Manual** -This manual provides general information that is common to RCC models and can be downloaded from our website to obtain user documentation and updates.  
 North America <https://hornerautomation.com>  
 Europe <http://www.horner-apg.com>

### 2.2.2 Four main types of information are covered in this manual

- a) Safety and installation guidelines / instructions (Mechanical and Electrical)
- b) Descriptions of hardware features (Serial ports, Removable Media, Communication Options, etc.)
- c) Configuration and use of the RCC
- d) Maintenance and support

### 2.2.3 Manual Index

Major topics of interest may be found in the [Index](#) towards the end of this manual.

## 2.3 Connectivity to the RCC

The RCC has excellent capabilities for connecting to a variety of devices. The diagram below shows some examples of devices that can be used with the RCC.

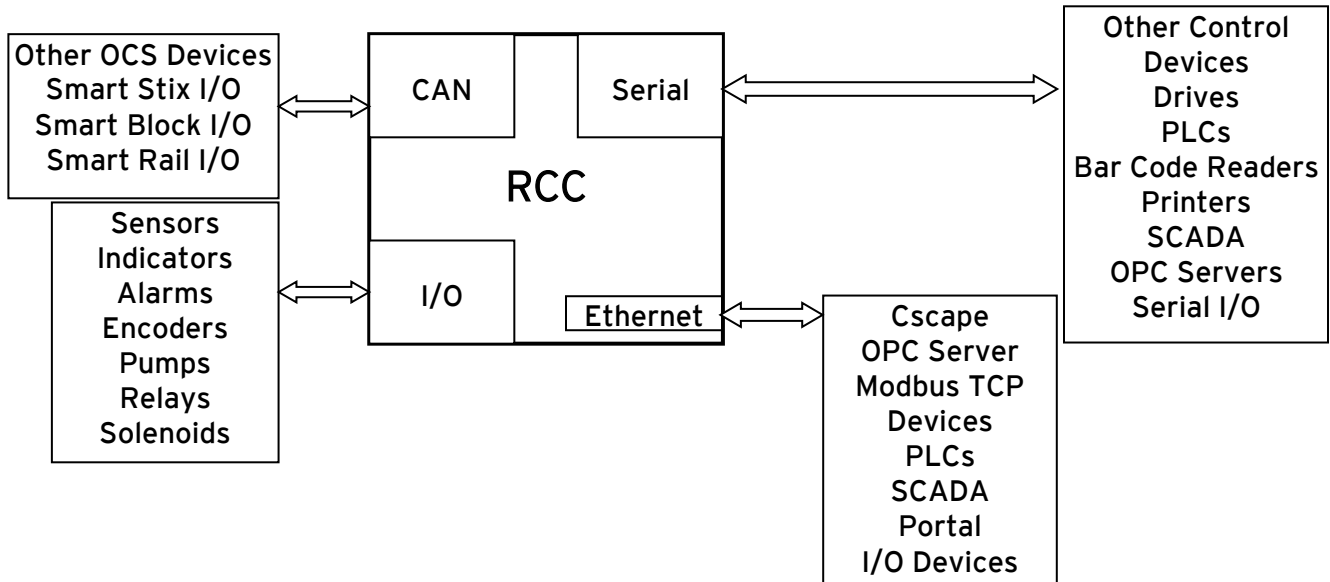

Figure 2.2–Visual Overview of Connectivity of the RCC OCS

## 2.4 Features of RCC

The RCC are industrial control devices with built in I/O. They combine control, I/O, and networking into a single, integrated package.

Unique features of the RCC include:

- Advanced control capabilities including floating point, multiple auto-tuning PID loops, and string handling capabilities
- Removable media for storage of programs, data logging, and on-site updating
- CsCAN networking for communication with remote I/O, other controllers, or PCs
- Configurable serial protocols for communication to drives, PLCs, or other serial peripherals
- Advanced high speed I/O capabilities
- Cscape programming software that allows all aspects of the RCC to be programmed and configured from one integrated application
- On board Ethernet port (10/100Mbps) for Cscape programming and application defined communication, with Auto MDI/MDI-X
- WebMI and Push capabilities for access from the Internet
- Small, compact, din-rail mountable logic controller with flexible built in I/O

## 2.5 Accessories

Please visit the Horner Control Accessories website for communication, programming, and I/O accessories.

North America: <http://hornerautomation.com/product-category/home/control-accessories/>  
Europe: <http://horner-apg.com/en/products.aspx>

## 2.6 Useful Documents and References

Visit our website to obtain user documentation, supplemental documents, certificates, and other documentation.

North America <https://hornerautomation.com>  
Europe <http://www.horner-apg.com>

## 2.7 Opening Cscape Help File

After opening the Cscape Help file, either use the Content, Index or Search tabs to located information. The Cscape Help file has more information than the scope of this user manual.

Select "Index" tab.

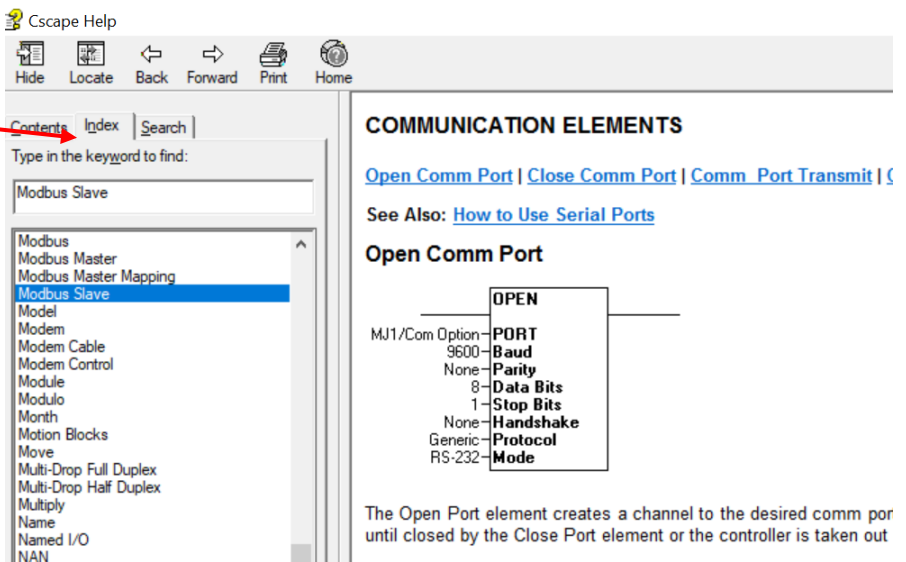

COMMUNICATION ELEMENTS	
<a href="#">Open Comm Port</a>   <a href="#">Close Comm Port</a>   <a href="#">Comm Port Transmit</a>   <a href="#">Comm Port Receive</a>	
See Also: <a href="#">How to Use Serial Ports</a>	
<b>Open Comm Port</b>	
	<b>OPEN</b>
MJ1/Com Option-	<b>PORT</b>
9600-	<b>Baud</b>
None-	<b>Parity</b>
8-	<b>Data Bits</b>
1-	<b>Stop Bits</b>
None-	<b>Handshake</b>
Generic-	<b>Protocol</b>
RS-232-	<b>Mode</b>

The Open Port element creates a channel to the desired comm port until closed by the Close Port element or the controller is taken out

## CHAPTER 3: MECHANICAL INSTALLATION

**NOTE:** The datasheet is the first document to refer to for information related to RCC models such as pin-outs, I/O and general specification, and other key installation information. Visit the Horner websites to obtain datasheets, user documentation, and updates.

### 3.1 Overview

The mechanical installation greatly affects the operation, safety, and appearance of the system. Information is provided to mechanically install the unit such as cutout sizes, mounting procedures and other recommendations for the proper mechanical installation of the unit.

### 3.2 RCC Dimensions

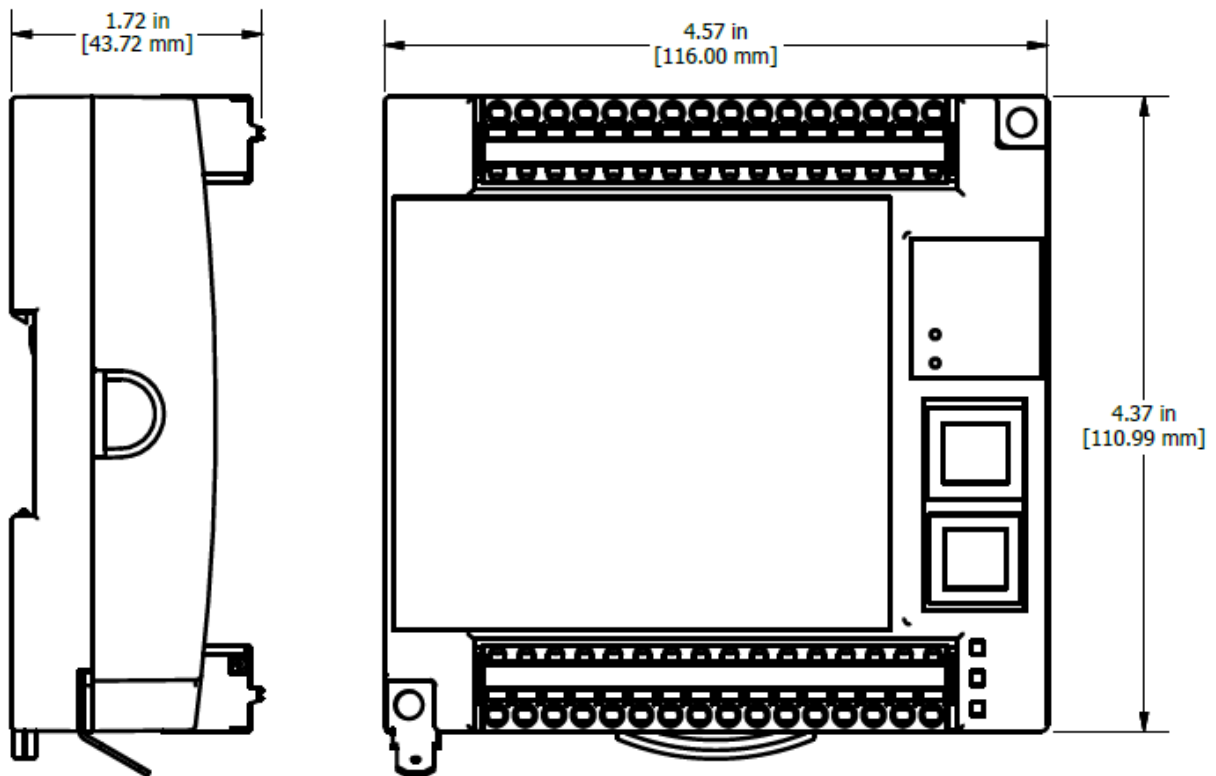

Figure 3.1 - RCC Dimensions

### ***3.2.1 Temperature / Ventilation***

Ensure that the DIN Rail layout design allows for adequate ventilation and maintains the specified ambient temperature range. Consider the impact on the design if operating at the extreme ends of the ambient temperature range. For example, if it is determined that a cooling device is required, allow adequate space and clearances for the device in the panel box or on the panel door if DIN rail is mounted inside.

### ***3.2.2 Orientation***

RCC should be mounted with locking DIN tab facing down.

### ***3.2.3 Noise***

Consider the impact on the panel layout design and clearance requirements if noise suppression devices are needed. Be sure to maintain an adequate distance between the RCC and noisy devices such as relays, motor starters, etc.

For details on output protection, especially when using contactors and solenoids see MAN0962.

### ***3.2.4 Shock and Vibration***

The RCC has been designed to operate in typical industrial environments that may inflict some shock and vibration on the unit. For applications that may inflict excessive shock and vibration please use proper dampening techniques or relocate the RCC to a location that minimizes shock and/or vibration.



## CHAPTER 4: ELECTRICAL INSTALLATION

**NOTE:** The datasheet is the first document to refer to for model-specific information related to RCC models for key installation information. Visit the Horner websites to obtain datasheets, user documentation, and updates.

### 4.1 Grounding Definition

**Ground:** The term **ground** is defined as a conductive connection between a circuit or piece of equipment and the earth. Grounds are fundamentally used to protect an application from harmful interference causing either physical damage such as by lightning or voltage transients or from circuit disruption often caused by radio frequency interference (RFI). Grounding is also for the safety of the user.

### 4.2 Ground Specifications

Ideally, a ground resistance measurement from equipment to earth ground is  $0\Omega$ . In reality, it typically is higher. The U.S. National Electrical Code (NEC) states the resistance to ground shall not exceed  $25\Omega$ . Horner APG recommends less than  $15\Omega$  resistance from our equipment to ground. Resistance greater than  $25\Omega$  can cause undesirable or harmful interference to the device.

### 4.3 How to Test for Good Ground

In order to test ground resistance, a Ground Resistance Tester must be used. A typical Ground Resistance Meter Kit contains a meter, two or three wire leads, and two ground rods.

Instructions are supplied for **GROUND RESISTANCE METER** either a two-point or three-point ground test.

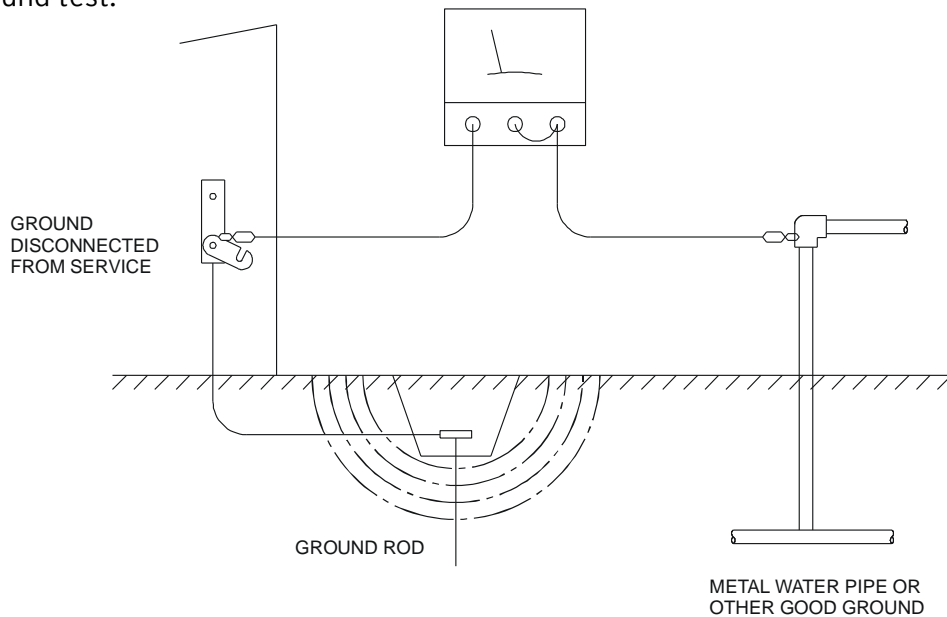

Figure 4.1 - Two-Point Ground Connection Test

To power the RCC unit, V+ and V- wires are directly wired to one of the terminal strips, similar to what is shown below on the RCC972. Earth Ground is the auxiliary spade at the bottom.

**NOTE:** Each RCC model has its own power connection on terminals different than those shown on the RCC972 here. For correct power connections, please refer to the datasheet specific to the RCC model being used.

Table 4.1 - Primary Power Port Pins		
PIN	Signal	Description
V+	DC IN	Input power supply positive voltage
C	0V	Input power supply ground

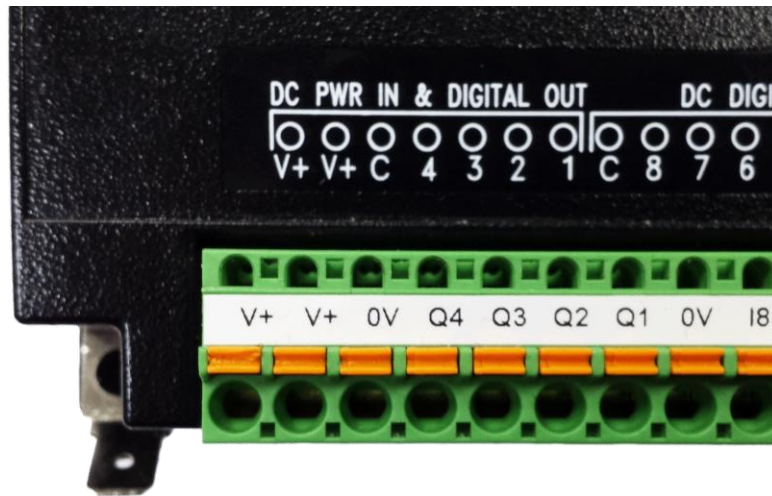

Figure 4.1 - RCC972 Power Connector (Primary Power Port)

## CHAPTER 5: SERIAL COMMUNICATIONS

### 5.1 Overview

All RCC models provide at least one serial port. On all models except for the RCC2414, the 8-pin modular connector labeled **MJ1** is for serial communications and contains a RS232 port (MJ1). On RCC1410 and RCC8842 models, the same connector also contains a 2-wire RS485 port (MJ2). By default, MJ1 can be connected to the COM port of a PC running Cscape, for controller programming. In addition, both MJ1 and MJ2 can be used for application-specific communication, using a variety of standard data exchange protocols.

On the RCC2414 model, there are two 2-wire RS485 ports located on the top terminal strip. They are labeled "Port1" and "Port 2" on the unit itself, and they are referred to as MJ1 and MJ2 in the programming software.

Refer to the datasheet specific to the RCC model being used for serial port pinouts.

### 5.2 MJ1 Serial Port Pinout

**NOTE:** Please refer to individual datasheets for more details.

Table 5.1 - Datasheets for RCC Models	
RCC Model	Datasheet
RCC972	MAN0970
RCC1410	MAN1034
RCC2414	MAN1033
RCC8842	MAN1073

**5.2.1. RCC972 MJ1 Pins**

Table 5.2 - RCC 972 MJ1 Pins		
Pin	RCC972 MJ1 Pins	
8	TXD	OUT
7	RXD	IN
6	0 V	Ground
5	+5V (60mA Max)	OUT
4	RTS	OUT
3	CTS	IN
2	N/C	
1	N/C	

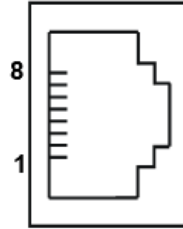

MJ1: RS-232–Use for Cscape programming and application-defined communications.

**5.2.2. RCC1410 MJ1 and MJ2 Pins**

Table 5.3- RCC1410: MJ1 and MJ2 Pins				
PIN	MJ1 Pins		MJ2 Pins	
	Signal	Direction	Signal	Direction
8	TXD	OUT	--	--
7	RXD	IN	--	--
6	0V	Ground	0V	Ground
5	+5V (60mA Max)	OUT	+5V (60mA Max)	OUT
4	RTS	OUT	--	--
3	CTS	IN	--	--
2	--	--	RX- / TX-	IN / OUT
1	--	--	RX+ / TX+	IN / OUT

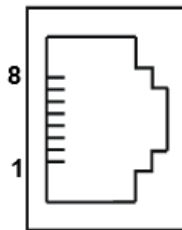

MJ1: RS-232 w/full handshaking.  
 MJ2: RS-485 half duplex.

### 5.2.3 RCC2414 Serial Port Pins

The RCC2414 has two serial ports that are provided via cage clamp terminals. Both are 2-wire RS-485 only.

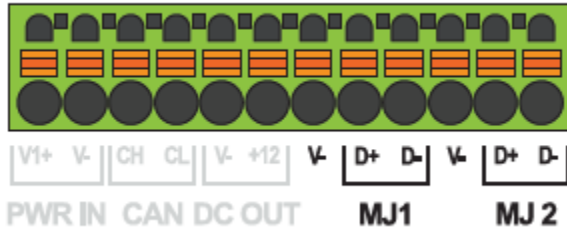
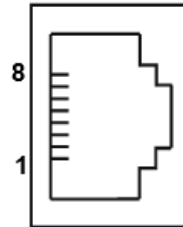

Figure 5.1 - RCC2414 Serial Port Pins

### 5.2.4 RCC8842 MJ1 and MJ2 Pins

MJ1: RS-232 w/full handshaking / MJ2: RS-485 half-duplex.



**NOTE:** Both serial ports are in one modular jack. To break pins out to terminals, use HE200MJ2TRM accessory.

Table 5.4 - RCC8842: MJ1 and MJ2 Pins				
PIN	MJ1 Pins		MJ2 Pins	
	Signal	Direction	Signal	Direction
8	TXD	OUT	--	--
7	RXD	IN	--	--
6	0V	Ground	0V	Ground
5	+5V (60mA Max)	OUT	+5V (60mA Max)	OUT
4	RTS	OUT	--	--
3	CTS	IN	--	--
2	--	--	RX- / TX-	IN / OUT
1	--	--	RX+ / TX+	IN / OUT

### 5.3 Cscape Programming via Serial Port

The MJ1 serial port supports CsCAN Programming Protocol (except RCC2414). If a PC COM port is connected to the MJ1 serial port, Cscape can access the RCC for programming and monitoring. Programming can also be done via the CAN connection or Ethernet. For serial port programming on MJ1, **HE-XCK Programming Kit** can be use (except RCC2414).

### 5.4 Ladder-Controlled Serial Communication

Using Serial Communication function blocks, both MJ1 and MJ2 ports support Generic ASCII for connection to such devices as barcode scanners or any other device that simply sends a string of text. Modbus Master and Modbus Slave Protocols are also supported on both ports in both ASCII and RTU formats. In addition, external modems can be connected and accessed using the Modem function block.

## CHAPTER 6: CAN COMMUNICATIONS

**NOTE:** For additional CAN information, refer to the CAN Networks manual (MAN0799) on the Horner websites.

### 6.1 Overview

All RCC models provide CAN networking options, which are implemented with CL and CH connections at the terminal. They are similar to the RCC972 shown below. The CAN connection is terminated (120Ω resistor) at each end of the network wiring for proper functionality.

**NOTE:** The order of the CL and CH connections differ depending on the RCC model being used. Please refer to the datasheet for the specific RCC being used.

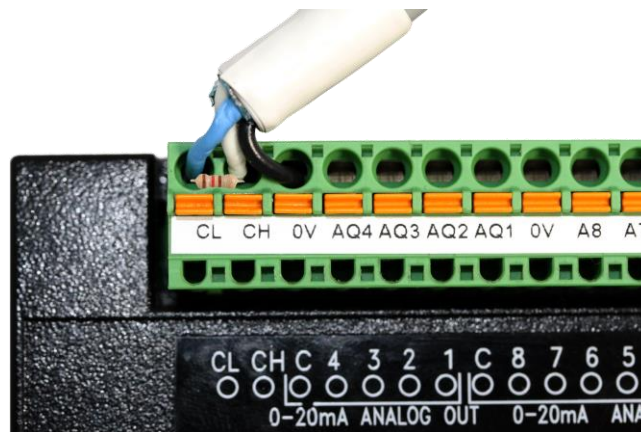

Figure 6.1 - CAN Connection

The CAN port can be used for RCC programming by connecting it to the CAN port of another OCS or RCC that is connected with Cscape. The CAN port also allows the RCC to exchange global data with other OCS/RCS controllers. CAN supports accessing of remote network I/O devices: SmartStix, SmartBlock, and SmartRail Modules.

### 6.2 Port Description

The RCC CAN ports implement the ISO 11898-2 physical layer and the CAN 2.0A data link layer standards. Also, since the CAN ports are powered by an internal isolated power supply, external CAN power is not required for the RCC CAN port itself. However, external CAN port power is required for remote I/O devices, such as SmartStix, SmartBlock, and SmartRail.



### 6.3 CAN Port Wiring

The CN L and CN H communication wires must be terminated with a 120 Ω resistor.

#### 6.3.1 RCC972 CAN Port Wiring

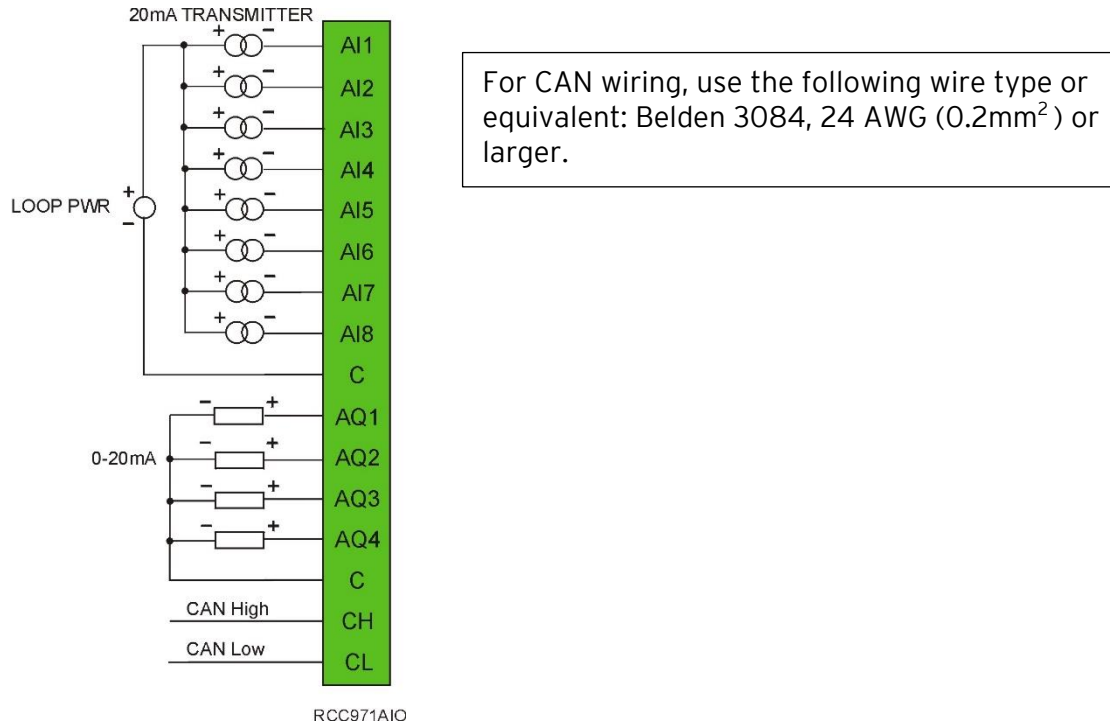
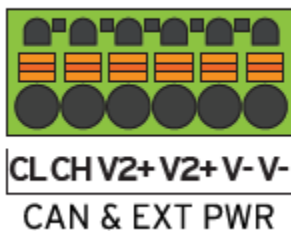

Figure 6.2 - RCC972 CAN Port Wiring

#### 6.3.2 RCC1410 CAN Port Wiring



CAN communications are provided via three connectors on the CAN connector: CAN\_LOW (CL), CAN\_HIGH (CH), and V- (C).

If CsCAN expansion I/O is to be used, a 24VDC power source will be required on the CsCAN bus in order to power the expansion I/O modules.

Figure 6.3 - RCC1410 CAN Port Wiring

### 6.3.3 RCC2414 CAN Port Wiring

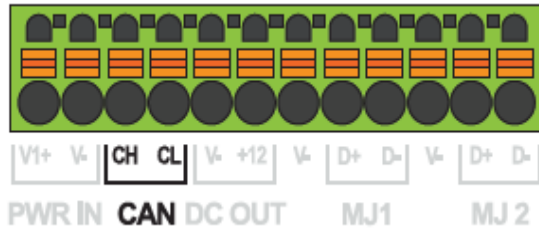

The CAN port is provided via three connections on the CAN, Power, and Analog connector: CAN\_LOW (CL), CAN\_HIGH (CH), and V- (C).

If CsCAN expansion I/O is to be used, a 24VDC power source will be required on the CsCAN bus in order to power the expansion I/O modules.

Figure 6.4 - RCC2414 CAN Port Wiring

### 6.3.4 RCC8842 CAN Port Wiring

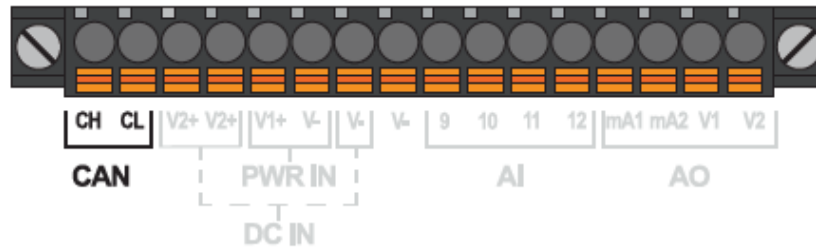

Figure 6.5 - RCC8842 CAN Port Wiring

The CAN port is provided via three connections on the CAN, Power, and Analog connector: CAN\_LOW (CL), CAN\_HIGH (CH), and V- (C).

If CsCAN expansion I/O is to be used, a 24VDC power source will be required on the CsCAN bus in order to power the expansion I/O modules.

## 6.4 Cscape Programming via CAN

The CAN port supports CsCAN Programming Protocol. If a PC has a CAN interface installed (via PCI card or USB), and the PC CAN port is connected to the RCC CAN port, Cscape can access the RCC for programming and monitoring.

In addition, the RCC supports single-point-programming of all RCC and other OCS/RCS devices that are connected to the CAN port network. If the PC COM port is connected to the RCC MJ1 serial port, the RCC can act as a pass-through gateway allowing Cscape to access all RCC and OCS/RCS devices that are attached to the CAN port network.

## 6.5 Ladder-Controlled CAN Communication

Using Put and Get Network Words function blocks, the CAN port can exchange digital and analog global data with other RCC or OCS/RCS devices (nodes) attached to the CAN port network.

In addition, Put and Get Network Heartbeat function blocks allow nodes on the CAN port network to regularly announce their presence and to detect the presence (or absence) of other nodes on the network.

## 6.6 Using CAN for I/O Expansion (Network I/O)

Connecting Network I/O devices (SmartStix, SmartBlock or SmartRail) to the RCC CAN port allows the RCC I/O to be economically expanded and distributed. A variety of modules are available for this purpose.

## CHAPTER 7: ETHERNET COMMUNICATION

### 7.1 MAC Address

**MAC Address:** The RCC MAC Address is found in System Registers %SR35-36. All Horner controllers hold 00-E0 in the first two segments. Therefore, the first two segments of the MAC Address are not represented in System Registers.

%SR36 holds the middle two segments of the address.

%SR35 holds the last two segments of the address.

**Example:** MAC Address 00-e0-c4-01-45-4e is held in %SR35/36 as follows:  
%SR35-16#454e and %SR36-16#c401 as viewed in Cscape Datawatch, format Hexadecimal.

### 7.2 Ethernet Module Protocols and Features

The following table describes the Ethernet Module Protocols and features supported by RCC.

Table 7.1 - Ethernet Module Protocols & Features	
Protocol / Feature	Protocol / Feature Description
ICMP (Ping)	Internet Control Message Protocol
EGD	Ethernet Global Data
SRTP Slave (90-30 Service Request)	Service Request Transfer Protocol
CsCAN TCP Server	Horner APG CsCAN over Ethernet (for Cscape to OCS programming)
Modbus Slave	Modbus over Ethernet
Ethernet / IP	ODVA CIP over Ethernet
FTP (File Server)	File Transfer Protocol
ASCII over TCP/IP (Web Server)	ASCII Data over Ethernet
NTP	Network Time Protocol (Obtain clock from web-based server)
HTTP Server	Hypertext Transfer Protocol (Web Server)

### 7.3 Ethernet System Requirements

Full Ethernet functionality requires:

- PC running Cscape Programming Software Version 9.3 SP6 or later (for configuration)
- RCC controller with onboard Ethernet port.

## 7.4 Ethernet Module Specifications

Table 7.2 - Ethernet Module Specifications	
<b>Speeds</b>	10 BaseT Ethernet (10Mbps) 100 BaseTx Fast Ethernet (100Mbps)
<b>Modes</b>	Half or Full Duplex
<b>Auto-Negotiation</b>	Both 10/100Mbps and Half/Full Duplex
<b>Connector Type</b>	Shielded RJ-45
<b>Cable Type</b> <i>(Recommended)</i>	CAT5 (or better) UTP
<b>Port</b>	Auto MDI/MDI-X (Auto Crossover)

## 7.5 Ethernet Module Configuration

**NOTE:** The following configuration is required for all applications regardless of the protocols used. Additional configuration procedures must be performed for each protocol used.

To configure the Ethernet Module, use Cscape Programming Software to perform the following steps:

1. On the main Cscape screen, select the **Controller** menu and its **Hardware Configure** sub-menu to open the Hardware Configuration dialog (Figure 7.1).
2. If configuring a different product model than the one shown in the Hardware Configuration dialog, click on the topmost **Config** button, select the desired PRODUCT Model, and then click **OK**.

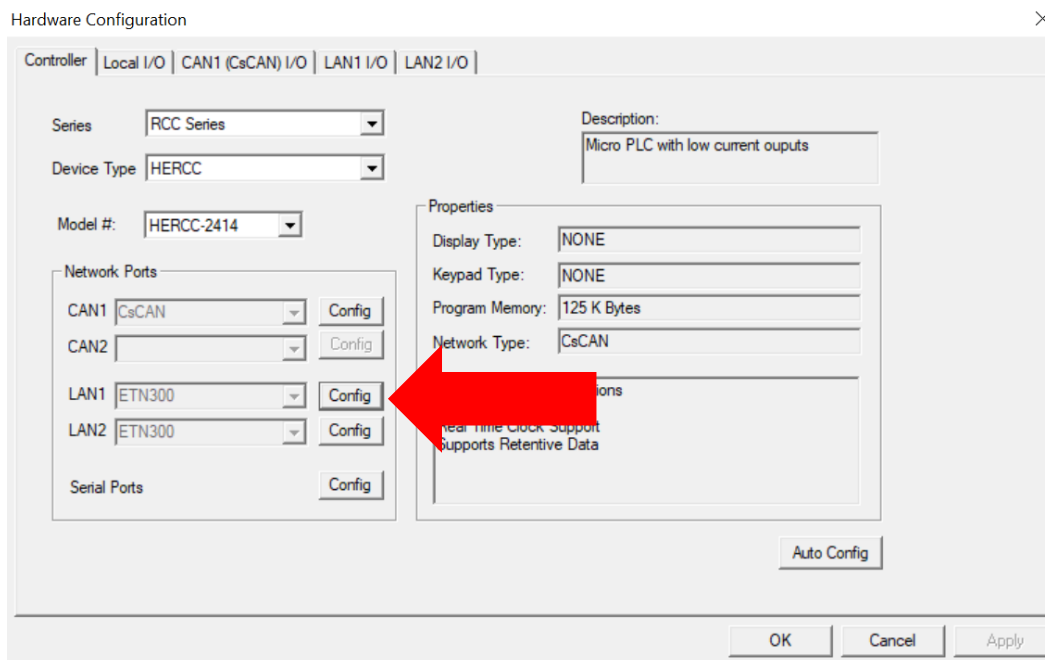

Figure 7.1 - Hardware Configuration Dialog

3. Click the **Config** button to the right of LAN1 revealing the Ethernet Module Configuration dialog as shown in Figure 7.2.

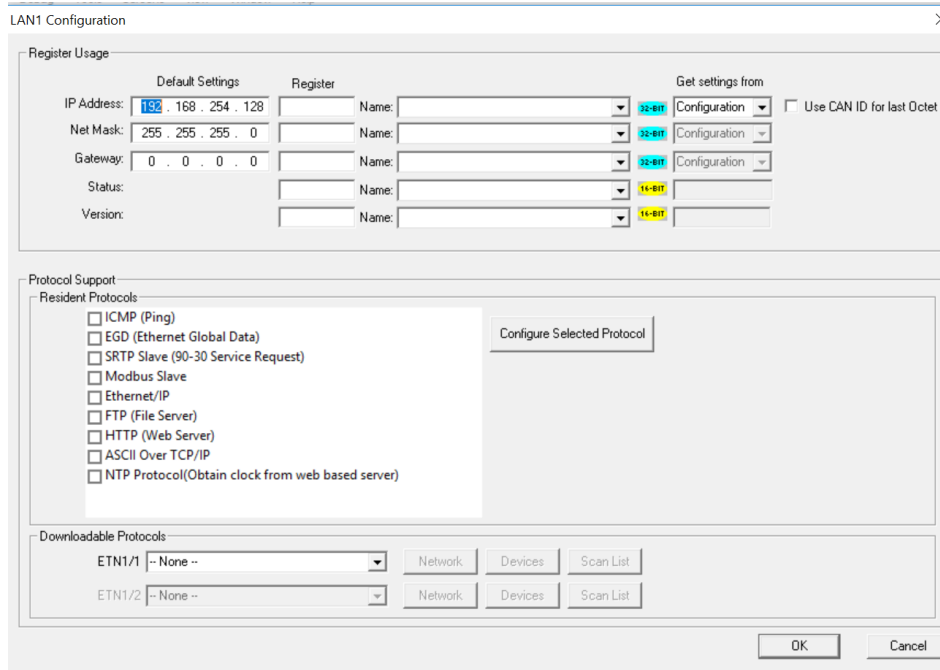

Figure 7.2 - Ethernet Module Configuration

4. Configure the Ethernet Module parameters as follows:

**IP Address:** Enter the static IP Address for the Ethernet Module being configured.

**NOTE:** *IP Addresses are entered as four numbers, each ranging from 0 to 255. These four numbers are called octets and they are always separated by decimal points.*

**Net Mask:** Enter the Net Mask (sometimes called Subnet Mask) being used by all nodes on the local network. Typical local networks use Class C IP Addresses, in which case the low octet (rightmost number) is used to uniquely identify each node on the local network. In this case, the default Net Mask value of 255.255.255.0 should be used.

**Gateway:** Enter the IP Address of a Gateway Server on the local network that allows for communication outside of the local network. To prevent the Ethernet Module from communicating outside the local network, set the Default Gateway IP Address to 0.0.0.0 (the default setting).

**Status Register:** Enter a register reference (such as %R100) to indicate which 16-bit register will have the Ethernet Status word written to it. Table 7.3 shows how this register value is formatted and explains the meaning of each bit in the Status Word.

Table 7.3 - Ethernet Status Word Register Format															
High Byte								Low Byte							
Bit 16	Bit 15	Bit 14	Bit 13	Bit 12	Bit 11	Bit 10	Bit 9	Bit 8	Bit 7	Bit 6	Bit 5	Bit 4	Bit 3	Bit 2	Bit 1
0	0	Dup	Spd	0	Rx	Tx	Link	TCP Connections							
Status Bit(s)		Status Indication						Status Values							
0		Reserved						Always 0							
Dup		Link Duplex (Auto-Negotiated)						0 = Half Duplex 1 = Full Duplex							
Spd		Link Speed (Auto-Negotiated)						0 = 10MHz 1 = 100MHz							
Rx		Receive State						0 = Inactive 1 = Active							
Tx		Transmit State						0 = Inactive 1 = Active							
Link		Link State						0 = Down 1 = Up							
TCP Connections		Total Number of Active TCP Connections (CsCAN, SRTP, Modbus, EIP, FTP, HTTP)						0 40							

**Version Register:** Enter a register reference (such as %R101) to indicate which 16-bit register will have the Ethernet Firmware Version written to it. The value stored in the Version Register is (Ethernet Firmware Version \* 100). For example, for Ethernet Firmware Version 4.30, the Version Register will contain 430. This version will only change with a complete controller Firmware Update.

### Ethernet Module Register Usage - Standard Configuration

To perform a standard configuration, fill in the **IP Address**, **Net Mask**, and **Gateway** with addresses that are valid for the network to which the controller is connected. If desired, registers may be specified in which these settings will be reflected. Leave the **Get settings from** selection set to **Configuration**.

Optionally, check the **Use CAN ID for last Octet** box in order to leave the last octet of the IP Address editable by way of changing the controllers CAN ID. This does not affect the Net Mask or Gateway settings.

**NOTE:** The low octet of the IP Address can be replaced with the unit's CAN Network ID, by checking the **Use CAN ID for last Octet** checkbox.

## 7.5 Ethernet Configuration - IP Parameters

For primary operation, the IP address, Net Mask, and Gateway should be set in the LAN config of the **Cscape Hardware Configuration**. There are options to get IP parameters from the LAN Config or to get parameters from registers. The following points on IP parameter configuration should be considered.

- **IP Parameters in Non-Volatile RAM:** The IP parameters of the Cscape LAN Config are written to non-volatile RAM on power down.
- **“Cscape LAN Config” / “Get Settings from” Configuration:** When ‘Get settings from’ is set to Configuration, the IP parameters specified under ‘Default Settings’ is used after downloading to the controller. After power cycle, the unit reverts to the last downloaded Cscape LAN Config that was loaded into non-volatile RAM at power down.
- **“Cscape LAN Config” / “Get Settings from” Register:** When ‘Get settings from’ is set to Register, the IP parameters are retrieved from the OCS registers assigned in LAN Config. Configured registers must be populated with the desired IP parameters. When the OCS is placed back into run mode, it reverts to the registers for IP parameters.

## 7.6 Ethernet Module Protocol Configuration

The **Protocol Support** area contains a list of the resident protocols supported by the platform being configured. To activate a protocol, check its checkbox.

For protocols that require additional configuration, click on a listed protocol to select it and then click the **Configure Selected Protocol** button. This will open a new dialog with configuration options for the selected protocol.

For detailed information on individual protocol configuration, refer to the latest version of the Ethernet Supplement, **SUP0740**.



## CHAPTER 8: DOWNLOADABLE COMMUNICATION PROTOCOLS

### 8.1 Overview

Through loadable protocol device drivers, certain models of the OCS family can provide the ability to exchange data with remote devices such as variable-frequency drives, PLCs, and remote I/O devices. This feature greatly expands the OCS 's control capability with negligible effect on the OCS 's ladder scan time.

Remote devices that communicate serially must do so under certain rules of data transfer known as a protocol. Many device manufactures have created their own protocol for communications with their device. For an OCS to communicate with a specific device, it must be loaded with the corresponding serial communications protocol device driver that supports that protocol.

A limited number of protocol device drivers are packaged with the Cscape distribution; however, as more are developed, they will be made available as add-on packages. A device driver is typically distributed as a Windows module, which contains the Configuration Menus, Help Files and the Target Executable Driver Code. When updating device drivers, an install routine loads the device driver to the Cscape directory structure and makes that driver available to Cscape applications.

Once installed, the protocol device driver can be included as part of a Cscape application by selecting it from a list of installed protocol device drivers and attaching it to the desired serial port (Program > Protocol Config menu). Only one protocol device driver can be associated with a serial port, though some OCS models support multiple protocols on a single Ethernet port.

Once the protocol is selected for a specific port, that port must be configured to match the bit transfer size and rate of the target device(s). This is configured under the **Network Config** menu, which contains port specific information such as the basic serial port parameters (i.e. baud rate, stop bits parity, retries, etc.). In addition to the serial port parameters, this menu also contains the transaction scan update control configuration and any network level protocol specific configuration.

Once the network is configured, each device on the serial communications network must be configured. For some communications (i.e. RS232), the network can be limited to one device. The devices are configured under the **Device Config** menu, which contains an arbitrary device name, the device ID and optionally an OCS status register that contains any device fault information.

Once each device(s) is configured, a **Scan List** of entries must be created which defines the transfer of data between a local (OCS) register(s) and a remote device register(s). These entries are created under the **Data Mapping** menu, which contains an OCS register, a target device ID, a target device register address, the number of registers to transfer, and update type.

Each entry can be configured for one of two types of initiating a transaction: **Polled and Triggered**. Polled type entries initiate a transaction with the remote device on every transaction scan. Triggered type entries only initiate a transaction when a corresponding local (OCS) binary trigger register is *set*. Once a triggered type transaction completes, the protocol device driver *resets* the local (OCS) binary register to indicate completion.

These basic types are also subdivided into Read or Write operations. For polled operations, a Read operation only reads from a remote device. Likewise, a Read/Write operation continuously reads from the remote device unless the target OCS register value changes from one ladder scan to another. In this case, the new OCS value is written to the target device. For triggered operations, only a Read or Write action is available.

When downloaded to the OCS, the Scan List is scanned sequentially to generate data transactions with the remote device. This transaction scanning can be on a continual basis (**automatic**) or controlled from ladder logic (**manual**) once a complex connection is programmatically created (i.e., dialup modem). The specific transaction-scanning mode is selected from the **Network Config** menu.

The following Horner Automation websites offer OCS Protocol Software Downloads.

North America <http://hornerautomation.com/support-files/>

Europe <http://horner-apg.com/en/products/software/ocs-protocols.aspx>

Please refer to the Cscape Help file for more information on Downloadable Protocols Configuration. After opening the Cscape Help file, select **Contents → Networking and Communications → Protocol Configuration**.

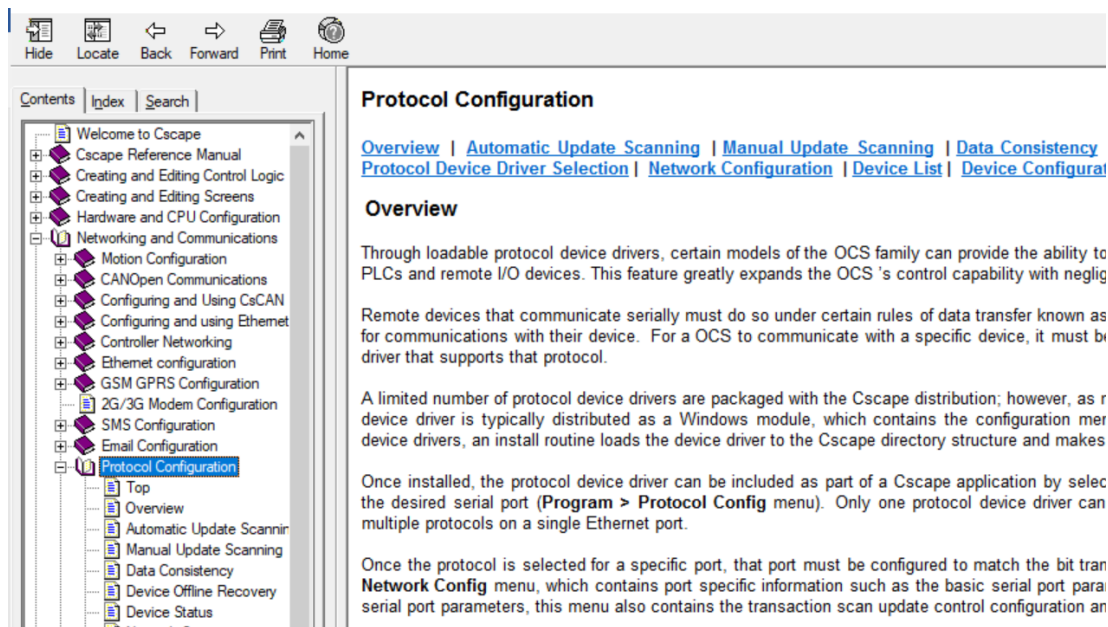

## 8.2 Protocol Config

After opening Cscape, choose **Program → Protocol Config**, and select the port drop-down box to select a protocol device driver. All protocol device drivers currently loaded in Cscape are displayed in the dropdown selection. Some OCS models can be limited in the number of ports or number of protocol device drivers that can be selected. Once a protocol is selected, the Network, Devices, and Data (Scan List) must be configured through corresponding dialogs accessible through the respective buttons (Network, Device, and Scan List.)

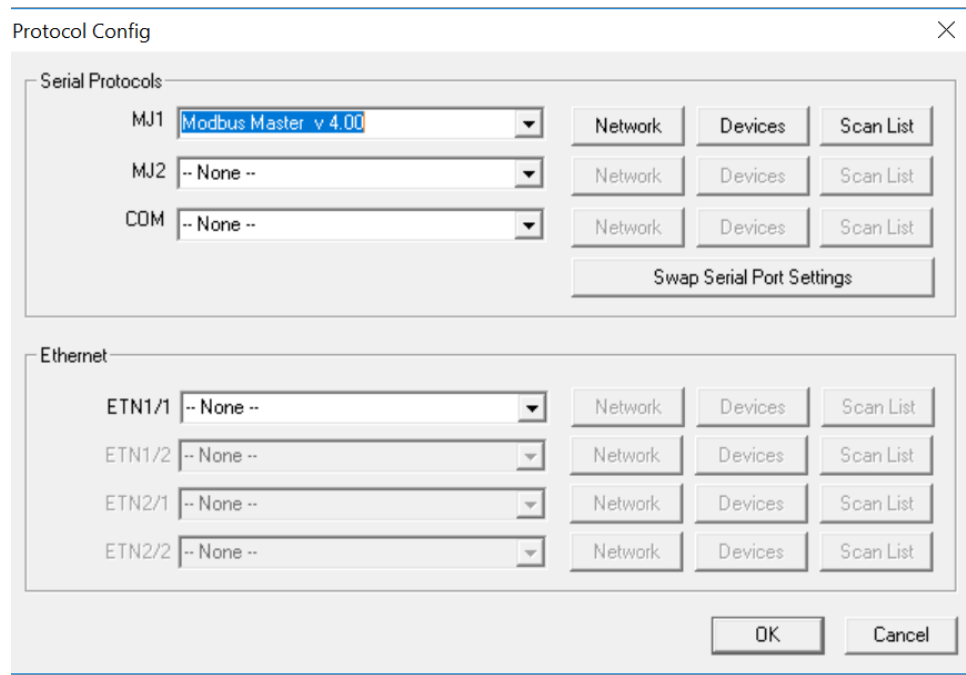

Figure 8.1 - Protocol Config Dialog

Three fields must be configured after a protocol is selected:

1. Network
2. Devices
3. Scan List

### 8.3 Network Configuration

Network Config (Modbus Master) ×

**Port Configuration**

Baud Rate: 9600	Protocol: Modbus RTU
Parity: None	Mode: RS-485
Data Bits: 8	Retries: 2 (0-255)
Stop Bits: 1	Timeout: 10000 mSec
Handshake: None	Slave Speed: Fast

**Update Scan**

Automatic  
 Update Interval: 0 mSec      ReacquireTime: 100000 mSec

Manual

Trigger:  Name:  1-BIT

ID Select:  Name:  16-BIT

**Master ID / Address**

Address:

**Status**

Register:  Name:  4 x 32-BIT

Network Configuration provides the required parameters to configure the network. Each protocol is different and may not require all the Network Config field. Please refer to the table below for the options in the Network Config field.

Table 8.1 - Network Protocols		
<b>Baud Rate, Data Bits, Stop Bits, Parity</b>	These field define the bit level transfer over the serial port.	
<b>Handshake</b>	<b>None</b> - No handshake lines are used <b>Multidrop Full</b> - Rx remains active while Tx is occurring. <b>Multidrop Half</b> - Rx is shut off while Tx is occurring. <b>Radio Modem</b> - Wait for CTS acknowledgement before transmitting (legacy radio modem support).	
<b>Protocol</b>	If a driver supports multiple protocols, it is selected here, (i.e. Modbus supports RTU or ANSI).	
<b>Mode</b>	Specifies if port operates in RS232 or RS485 mode.	
<b>Retries</b>	Specifies number of times a transaction is retried on a failed response.	
<b>Timeout</b>	Specifies the amount of time for a device to wait for a valid response.	
<b>Update Scan</b>	<b>Automatic</b>	<b>Update Interval</b> - Specifies the update interval at which all the mapped entries are executed.
		<b>Reacquire Time</b> - Specifies the amount of time to wait before attempting communications with an offline device.
	<b>Manual</b>	<b>Trigger</b> - Specifies the binary register that a single transaction scan of the Scan List.
		<b>ID Select</b> - If an analog is specified in the field, the ID Select filter is enabled.
<b>Status Register</b>	Specifies the starting OCS register of eight (8) consecutive registers (4-32bit counters), which provide an indication of the network health.	
<b>Scanner Address</b>	Specifies the OCS's device (network) ID if a master ID is required by the protocol.	
<b>Protocol Help</b>	Provides protocol specific help.	

## 8.4 Device List and Device Configuration

### Device List

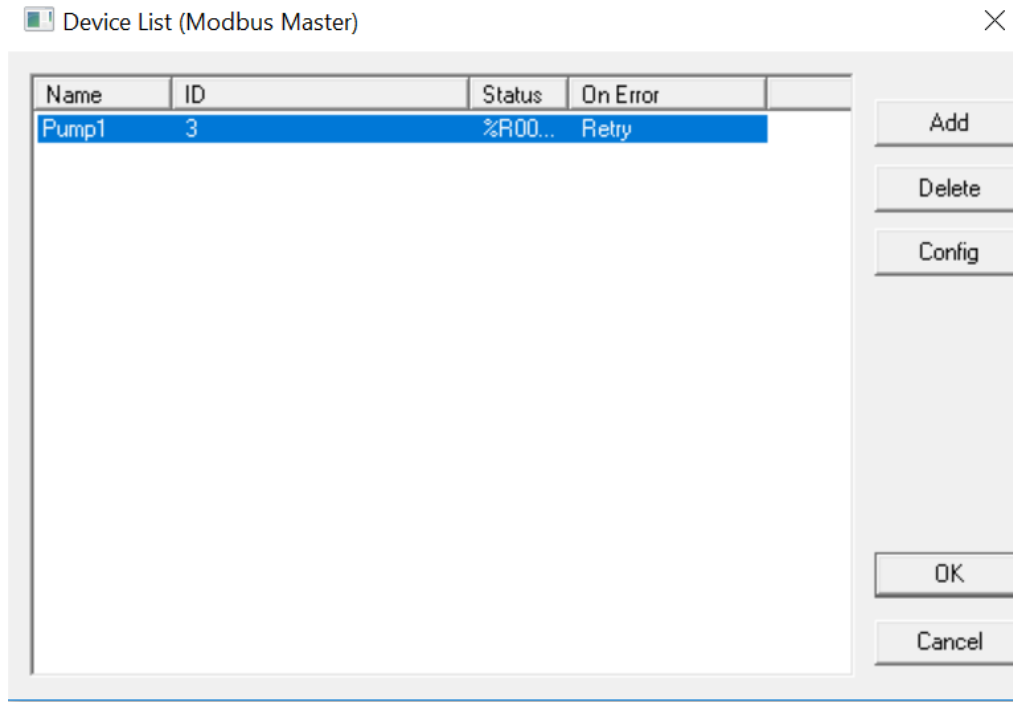

The Device List is reached from the Device button on the Protocol Config screen and provides a list of the configured devices on the Network. Devices must be created and exist in this list before corresponding Scan List entries can be created for this device. Typically, the number of entries is limited to **64 devices**.

## Device Configuration

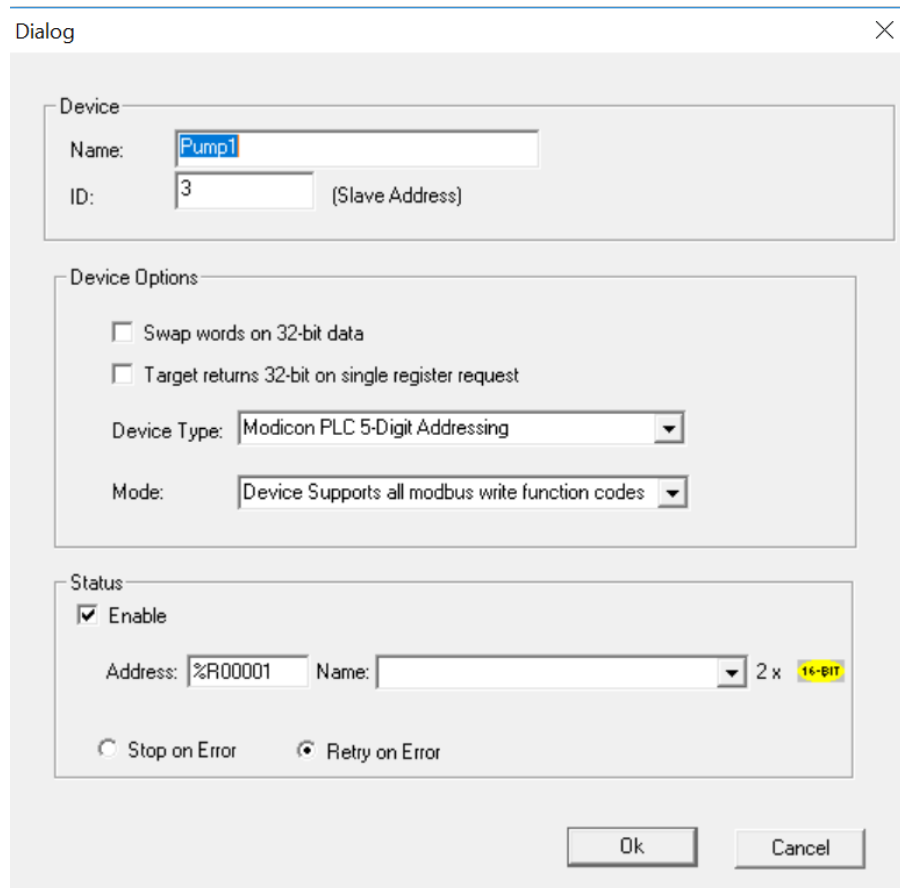

The image shows a 'Dialog' window for device configuration. It is divided into three main sections: 'Device', 'Device Options', and 'Status'.  
1. **Device Section:** Contains a 'Name' field with 'Pump1' and an 'ID' field with '3' (Slave Address).  
2. **Device Options Section:** Includes two unchecked checkboxes: 'Swap words on 32-bit data' and 'Target returns 32-bit on single register request'. It also features a 'Device Type' dropdown menu set to 'Modicon PLC 5-Digit Addressing' and a 'Mode' dropdown menu set to 'Device Supports all modbus write function codes'.  
3. **Status Section:** Has a checked 'Enable' checkbox. Below it is an 'Address' field with '%R00001' and a 'Name' dropdown menu. To the right of the dropdown is '2 x' and a yellow '16-BIT' label. At the bottom of this section are two radio buttons: 'Stop on Error' (unselected) and 'Retry on Error' (selected).  
At the bottom right of the dialog are 'Ok' and 'Cancel' buttons.

This configuration is reached from the Device List when adding or modifying an existing device.

## 8.5 Scan List

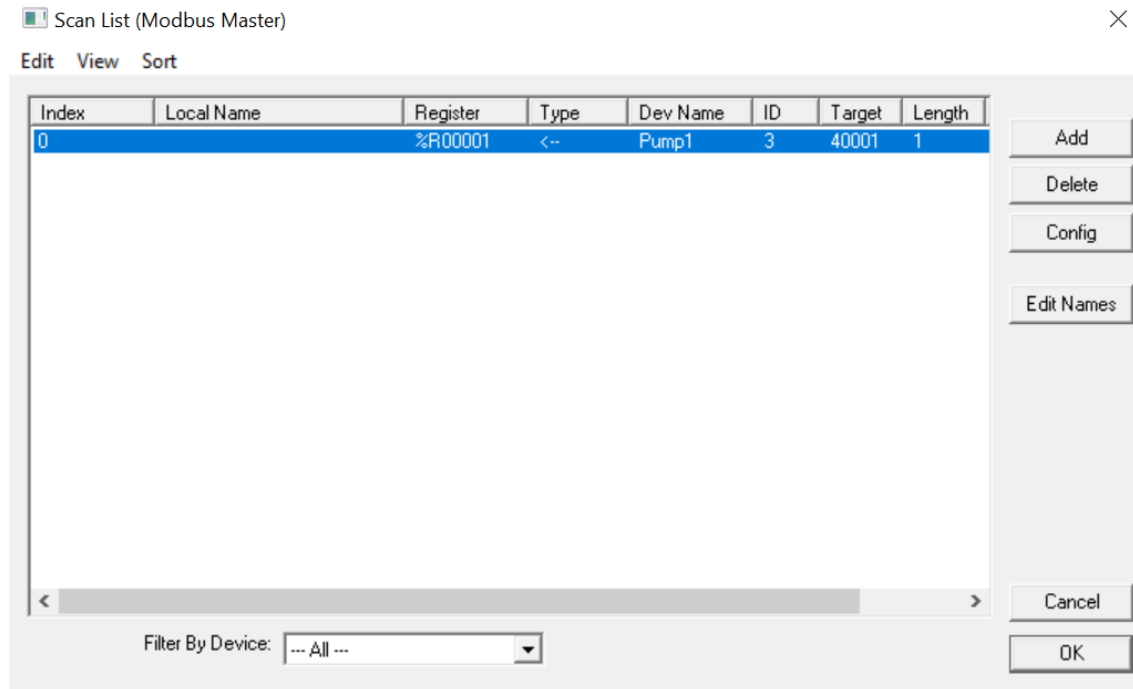

This can be accessed from the Scan List button on the Protocol Config screen or the Mapping button on the Device List screen and provides a Scan List of the Data Mapping entries. To transfer data between the OCS and remote target, a Scan List must be created that defines each transaction. Each mapping entry (transaction) contains the source and destination registers, the number of consecutive registers transferred, the direction of the transfer and what triggers the transfer. Typically, the number of entries is **limited to 512**.

**NOTE:** The order of the Scan List is the order in which the transactions occur. Sort functions are provided to change the order of the list. Each entry also has an identifying index. If the device status register is enabled and a transaction failure occurs, the status register indicates the index number of the transaction that has failed.



## 8.6 Data Mapping Configuration (Scan List Entry)

Dialog ×

**Target**

Device Name: Pump1 (3) ▼

Device Register: R123 >  32 bit access

Length: 1

---

**Local**

Register: %SR056 Name: LAST\_KEY ▼

---

**UpdateType**

Polled Read                       Triggered Read  
 Polled Read/Write                       Triggered Write  
 Polled Read/Write Init

Trigger Register:  Name:  ▼

### Update Type

This field specifies the direction and what triggers the transfer of data between the OCS and target device for a mapping entry.

### Polled Read

On every transaction scan, a read-only target device register(s) transaction occurs.

### Polled Read/Write

On every transaction scan, a read target device register transaction occurs unless a local register value has changed. The write transaction only updates those local registers that have changed in value. If several non-consecutive local registers (contained in a single mapping entry) change value between transaction scans, it takes several consecutive transaction scans to write each changed register.

When the OCS is placed in RUN mode, **the initial action for this mapping type is a read target register transaction.** This transaction initializes the local (OCS) register(s) to match that of the remote device register(s). Thereafter, any change to the corresponding OCS register(s) triggers a write operation to the remote device.

### Polled Read/Write/Init

On every transaction scan, a read target device register transaction occurs unless a local register value has changed. The write transaction only updates those local registers that have changed in value. If several non-consecutive local registers (contained in a single mapping entry) change value between transaction scans, it takes several consecutive scans to write each changed register.

When the OCS is placed in RUN mode, **the initial action for this mapping type is a write target register transaction.** This transaction initializes the target device register(s) to match that of the local (OCS) register(s). Thereafter, any change to the corresponding OCS register(s) triggers a write operation to the remote device.

The initial write transaction does not occur until after the first logic scan of the OCS. This allows registers to be initialized locally before Writing to the target device register(s).

### Triggered Read

A read transaction is triggered by a high level on a separately designated OCS (binary) trigger register. Once the read transaction is complete (or the device is offline), the OCS trigger register is cleared by the OCS. This update type can be used for occasion data accesses such as retrieving trend data.

**NOTE:** This operation increases the associated transaction scan time and can cause the **Update Interval Exceeded Counter** to increment on a tightly adjusted update interval.

### Triggered Write

A write transaction is triggered by a high level on a separately designated OCS (binary) trigger register. Once the write transaction is complete (or the device is offline), the OCS trigger register is cleared by OCS. This function can be used for occasion data accesses such as sending recipe data.

**NOTE:** This operation increases the associated transaction scan time and can cause the **Update Interval Time Exceeded Counter** to increment on a tightly adjusted update interval.

## CHAPTER 9: REMOVABLE MEDIA

### 9.1 Overview

All RCC models provide a Removable Media slot, labeled **Memory Card**, which supports standard microSD flash memory cards. microSD cards can be used to save and load applications, to capture graphics screens and to log data for later retrieval.



Figure 9.1 - Removable microSD Memory Card Slot

### 9.2 microSD Cards

Cards labeled either microSD or TransFlash that are in FAT32 format are compatible with the RCC Memory slot. Sizes up to 128GB have been tested at the time of this writing.

The Memory slot is equipped with a “push-in, push-out” connector and a microSD card can be safely inserted into the Memory slot whether the RCC power is On or Off.

***To install a microSD card:*** Align its 8-pin gold edge connector down, card label facing the front of the RCC unit as shown in Figure 8.1; then carefully push it all the way into the memory slot. Ensure that it clicks into place.

***To remove the microSD card:*** Push in on the top of the card gently to release the spring. The card pops out for removal.

### 9.3 microSD File System

The microSD Memory slot uses the PC-compatible FAT32 File System. This means that a PC, with a microSD-compatible card reader, can read files that have been written by the RCC and can write files that can be read by the RCC.

However, the RCC does not support long filenames, but instead implements the 8.3 filename format. This means that all file and directory names must consist of up to eight (8) characters, followed by an optional dot, and an optional extension with up to three (3) characters.

Directories and sub-directories can be nested up to 16 levels deep as long as each pathname string does not exceed 147 characters.

## 9.4 Using Removable Media to Log Data

Using Read and Write Removable Media function blocks, an application ladder program can read and write RCC register data in the form of comma-delimited files, with a .CSV extension. These files are compatible with standard database and spreadsheet PC programs. In addition, an application ladder program can use Rename and Delete Removable Media function blocks to rename and delete files.

## 9.5 Using Removable Media to Load and Save Applications

A special file type, with a .PGM extension, is used to store RCC application programs on microSD.

Pressing and holding the **LOAD** button for three seconds upon power up will load the program that is stored on the microSD (more details in Chapter 13).

Cscape can also save an application directly to a microSD card, which is plugged into the PC's microSD compatible card reader by selecting the Export to Removable Media item on the Cscape File menu.

## 9.6 Removable Media (RM) Function Blocks in Cscape

**NOTE:** For detailed information regarding RM function blocks and parameters, refer to the help file in Cscape Software.

The following RM functional blocks are available in Cscape Software. These function blocks will reference

- microSD when filename is prefixed with 'A:' or nothing.

Table 9.1 - RM Functional Blocks	
<b>Read RM csv</b>	Allows reading of a comma-separated value file from the microSD interface into the controller register space.
<b>Write RM csv</b>	Allows writing of a comma-separated value file to the microSD interface from the controller register space.
<b>Rename RM csv</b>	Allows renaming a file on the RM card. The data in the file is not changed.
<b>Delete RM csv</b>	Allows deleting a file on the RM card.
<b>Copy RM csv</b>	Allows copying a file on the RM card. The data in the file is not changed.

## 9.7 Filenames used with the Removable Media (RM) Function Blocks

The RM function blocks support the flash with a DOS/Windows standard FAT-16 file system. All names must be limited to the "8.3" format where the filename contains eight characters a period then a three-character extension. The entire filename including any path must be less than or equal to 147 characters.

When creating filenames and directories it is sometimes desirable to include parts of the current date or time. There are six special symbols that can be entered into a filename that are replaced by the RCC with current time and date information.

Table 9.2 - Filename Special Symbols		
Symbol	Description	Example
\$Y	Substitutes the current 2-digit year	2014 = 14
\$M	Substitutes the current month with a 2-digit code	March = 03
\$D	Substitutes the current day	22 <sup>nd</sup> = 22
\$h	Substitutes the current hour in 24-hour format	4 pm = 16
\$m	Substitutes the current minute	45 = 45
\$s	Substitutes the current second	34 = 34

**NOTE:** All the symbols start with the dollar sign (\$) character. Date symbols are in upper case, time symbols are in lower case.

The following are examples of the substituted time/date filenames:

Current date and time	= March 1, 2013 3:45:34 PM
Filename: Data\$M\$D.csv	= Data0301.csv
Filename: Year\$Y\Month\$M\aa\$D_\$h.csv	= Year04\Month03\aa01_15.csv
Filename: Month_\$M\Day_\$D\h_\$m_\$s.csv	= Month_03\Day_01\15_45_34.csv

**NOTE:** Time/Date requires setting on the RCC972 and is only maintained while the RCC is powered. Time and Date will need to be reconfigured on power cycle.

## 9.8 System Registers used with RM

Table 9.3 - RM System Registers	
<b>%SR174 Removable Media Protect</b>	Write a 1 to prohibit read/write access to the removable media card. Write a zero (0) to allow access.
<b>%SR175 Status</b>	This shows the current status of the RM interface.
<b>%SR176 Free Space</b>	This 32-bit register shows the free space on the RM card in bytes.
<b>%SR178 Card Capacity</b>	This 32-bit register shows the total card capacity in kilobytes.

Possible status values are shown in the table:

Table 9.4 - RM Status Values	
0	RM interface OK
1	Card present but unknown format
2	No card in slot
3	Card present, but not supported
4	Card swapped before operation was complete
5	Unknown error

For additional status information, consult the Cscape Help File.

## CHAPTER 10: GENERAL I/O

**NOTE:** Each RCC unit is sent with a datasheet in the box. The datasheet is the first document to refer to for model-specific information related to RCC models for key installation information. Visit the Horner websites to obtain datasheets, user documentation, and updates.

### 10.1 Overview

The RCC is a compact unit that contains high density, very versatile I/O. Using the I/O properly requires wiring to the proper terminals unit and configuring Cscape properly. This section will offer some tips and suggestions to configure the I/O properly. For the register mapping of the I/O, refer to the [Index](#) at the end of this manual for the pages referencing register mapping.

### 10.2 Solid-State Digital Outputs

Solid-state digital outputs are generally used to activate lamps, low voltage solenoids, relays, and other low voltage and low current devices.

**NOTE:** The digital outputs used on RCC controllers are “sourcing” outputs. This means the output applies a positive voltage to the output pin when turned ON. When turned off, the output applies approximately zero volts with respect to the I/O ground.

The digital outputs used in the RCC have electronic short circuit protection and current limiting. While these electronic protections work in most applications, some application may require external fusing on these outputs.

The digital outputs in the RCC are typically controlled via %Q bits in the register mapping.

When the controller is stopped the operation of each output is configurable. The outputs can hold the state they were in before the controller stopped or they can go to a predetermined state. The default behavior for an output when entering stop mode is for the digital outputs to turn off. For more information on Stop State see the [Index](#) to find pages referencing Cscape settings.

### 10.3 Digital Inputs

**NOTE:** The digital inputs on the RCC are designed for low-voltage DC inputs. The inputs are designed to support both positive and negative input modes. The mode is set by a configuration parameter in Cscope. All the inputs on the unit must be configured to the same mode.

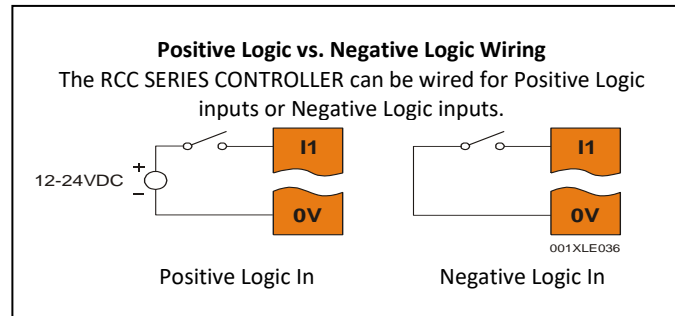

Figure 10.1 - Positive and Negative Inputs

In positive logic mode a positive voltage applied to the input will turn the input. The internal design of this mode is basically a resistor from the input to I/O ground. This mode is sometimes called sourcing.

In negative logic mode, connecting the input to the I/O ground or 0V will turn the input on. The internal design of this mode is basically a resistor from the input to the positive I/O voltage (usually 12 or 24V). This mode is sometimes called sinking.



## 10.4 Analog Inputs

**NOTE:** See the data sheet for the RCC model being used and see the appropriate page in this manual (see [Index](#)) for details on how to use Cscape to configure the digital filtering.

The analog inputs on certain RCC models allow voltage or current measurement from a variety of devices.

Analog inputs may read 0-20 mA current only or may also read 0-10VDC. **Refer to the datasheet specific to the RCC model being used.**

The analog inputs have a digital filter that can be used to filter electrical noise that may be unavoidable in some installations. The downside to digital filtering is the inputs will respond more slowly to sudden changes in the actual input.

For more information on analog input configuration and use, see the chapter on Cscape Configuration.

### 10.4.1 Common Cause of Analog Input Tranzorb Failure.

If a 4-20mA circuit is initially wired with loop power but without a load, the analog input could see 24VDC. This is higher than the rating of the tranzorb.

This can be solved by not connecting loop power prior to load connection or by installing a low-cost PTC in series between the load and the analog input.

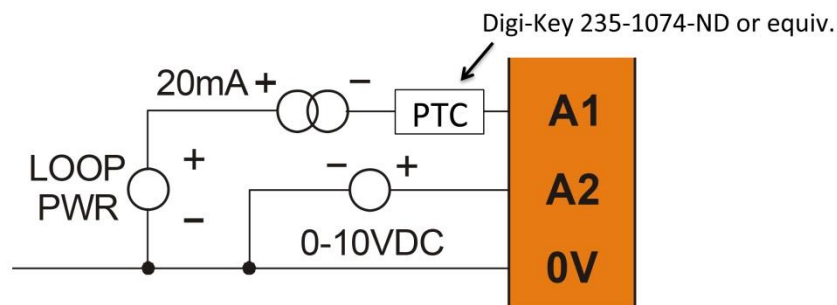

Figure 10.2 - Analog Input Tranzorb - Troubleshooting

## 10.5 Analog Outputs

The analog outputs on RCC devices may provide only 0-20mA output or may also provide a 0-10VDC output. **Refer to the datasheet specific to the RCC model being used.**

When the controller is stopped, the operation of each output is configurable. The outputs can hold the state they were in before the controller stopped, or they can go to a predetermined value. By default, analog outputs are set to a value of zero. For more information on Stop State, refer to the appropriate pages (see [Index](#)) for the configuration chapter for Cscape settings.

# CHAPTER 11: CSCAPE CONFIGURATION

## 11.1 Overview

RCC hardware is programmed with a Windows based PC application called Cscape. This application can be used to program, configure, monitor and debug all aspects of the RCC unit. Please see the online help provided with Cscape for additional details.

## 11.2 Cscape Status Bar

When the RCC is connected to a PC using Cscape software, a Status Bar appears at the bottom of the screen. The Cscape Status Bar can be used to determine if communications have been established between the RCC and the Cscape program. Components of the Cscape Status Bar are explained below.

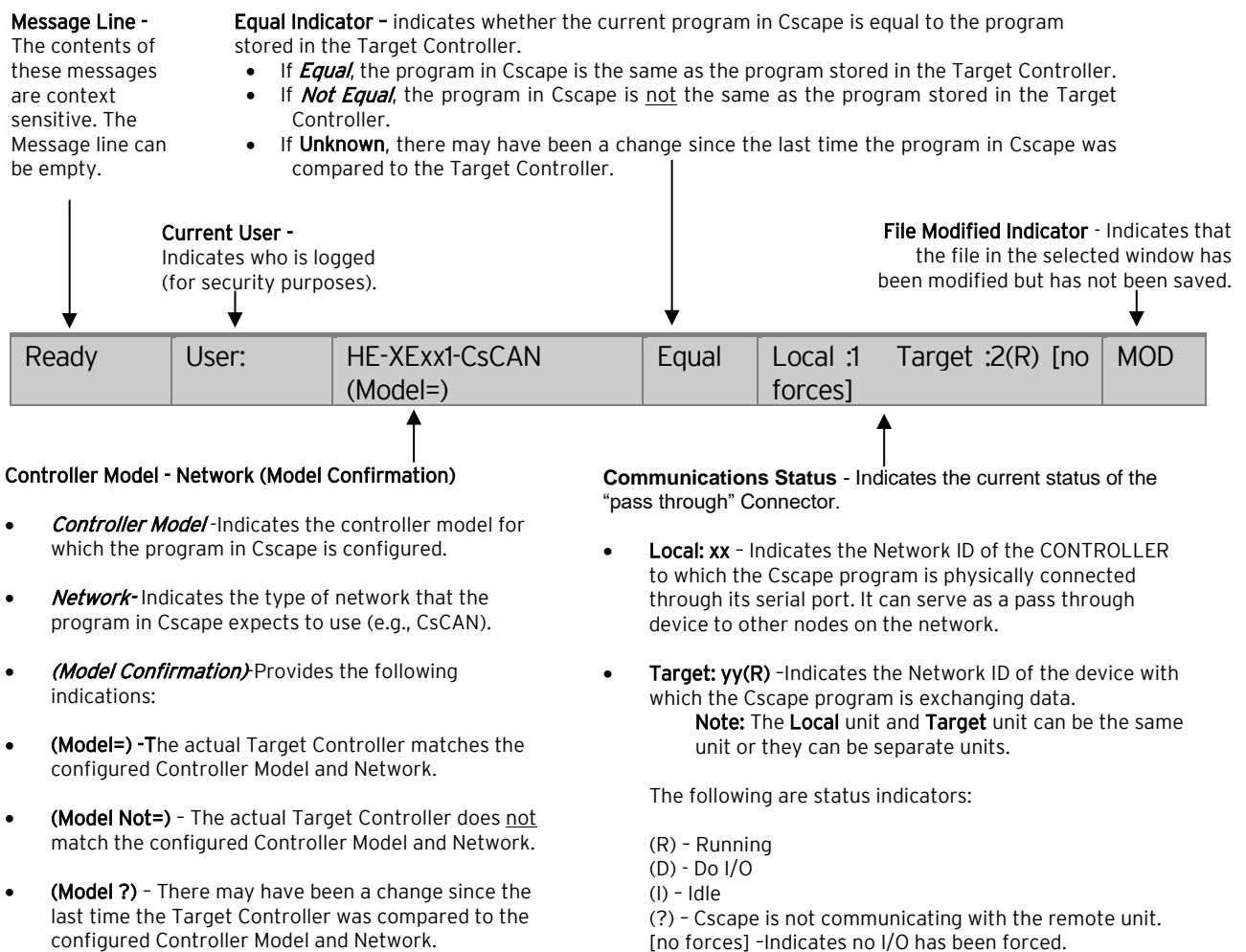

Figure 11.1 - Cscape Status Bar

### 11.3 Establishing Communications

The RCC can communicate with Cscape using serial port communications via MJ1 Port, Ethernet, and CAN (CsCAN). On the RCC2414 model, programming via USB is also available.

For RCC, use Cscape Version 9.30 SP6 or later.

Connect a PC (Personal Computer running a Windows Microsoft operating system) serial port to the MJ1 port on the RCC. CBL600 adapter and cable can be used to connect the MJ1 port to the PC's USB port.

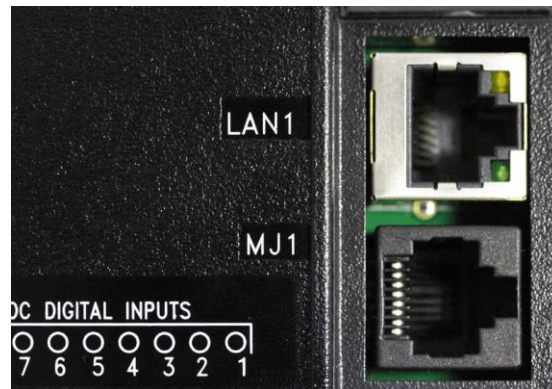
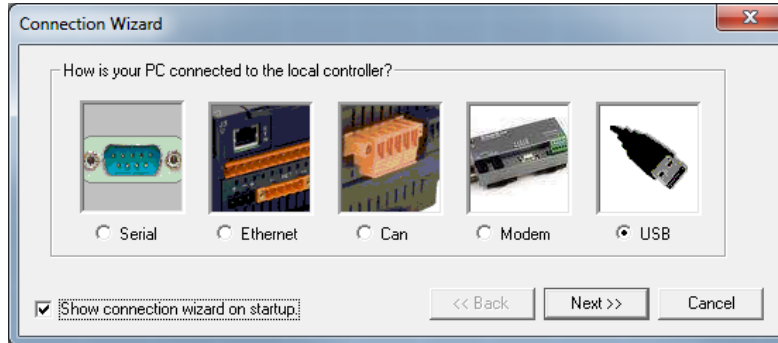

Figure 11.2 - MJ1 Connector to be used via Serial or with Serial to USB adapter to PC

The PC will detect a new device has been plugged into the USB port.

Now that the RCC is plugged in, go to **Cscape → Controller → Connection Wizard**. If you are just opening Cscape, Connection Wizard usually opens by default.



Select USB and click **Next >>**.

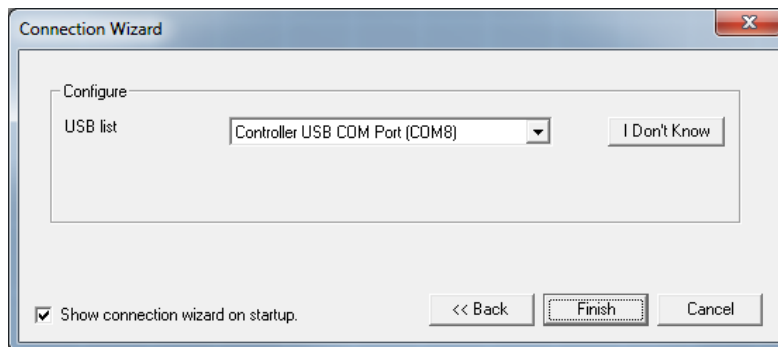

If the Connection Wizard does not pop up upon opening Cscope, then select **Controller** (in the Cscope tool bar) → **Connection Wizard**, choose your connection method. If you are connecting for the first time, we suggest connecting via USB.

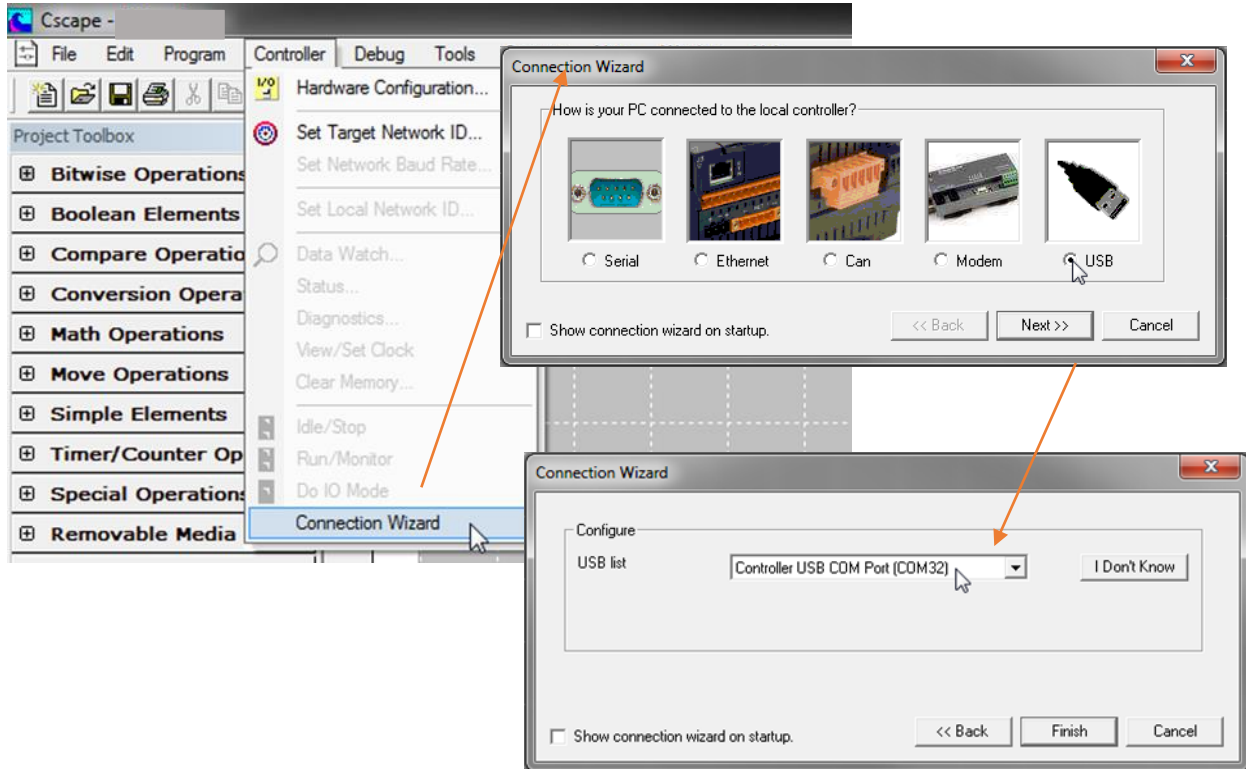

Figure 11.3 - Cscope Connection Wizard Screenshots

If **Controller USB COM Port** is not present in the dropdown list, the Windows operating system has not yet recognized the OCS as an installed device. Be sure the installation process is complete and that the correct drivers are installed. The Connection Wizard must be completely closed and reopened to refresh the USB dropdown list.

An alternate way to select the COM setting is to go to **Cscape** → **Tools** → **Application Settings** → **Communication** and choose the USB port.

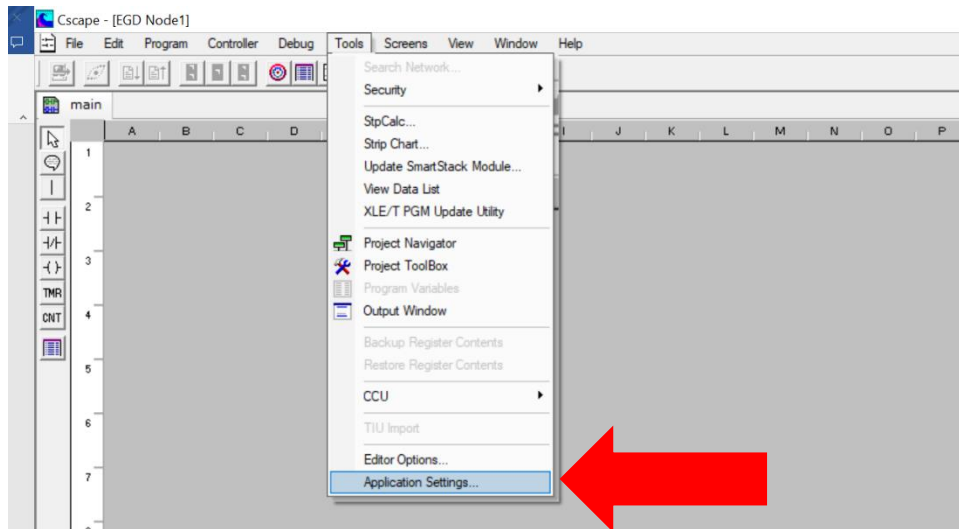

Figure 11.4 - Cscape: Alternative Connection Method Screenshot

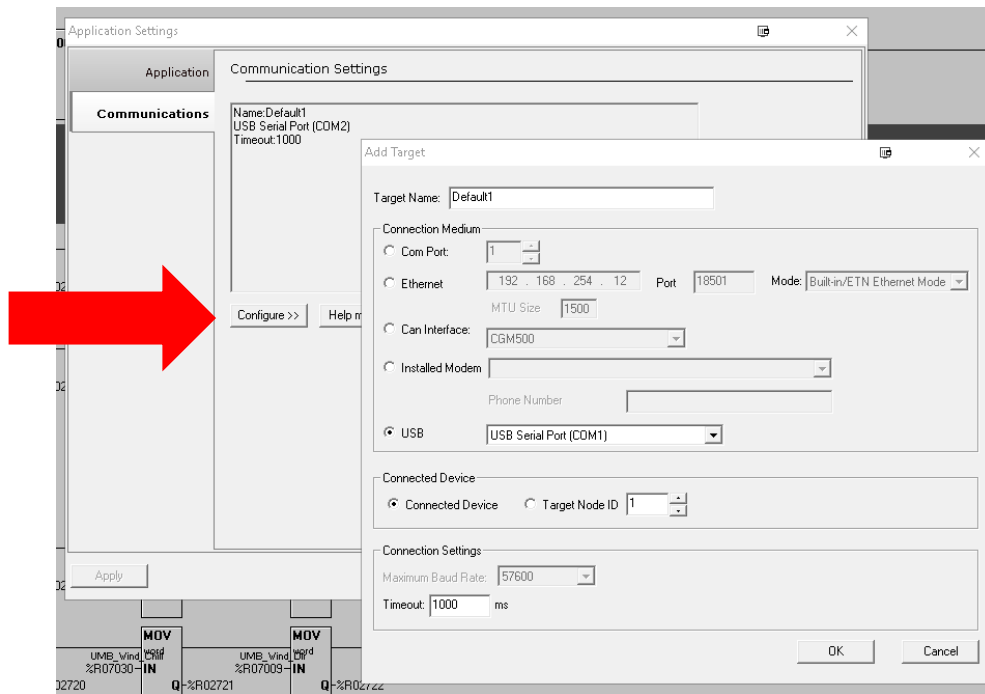

Figure 11.5 - Add Target Screenshot in Cscape

**NOTE:** The following fields, Target Name, Connection Medium, Connected Device, and Connection Settings, need to be filled for communication configuration if Cscape Connection Wizard was not used. Table 15.1 below explains the information needed in each field.

Table 11.1 - Communication Configuration Dialog	
<b>Target Name</b>	Name for connection. This is not a mandatory column to be filled, by default Cscape will populate 'Default1' in edit box.
<b>Connection Medium</b>	
<b>Com Port</b>	Select this option to communicate over serial communication with the device. The port number can be configured here.
<b>Ethernet</b>	<p>Select this option to communicate over Ethernet. Provide the IP address of the device and select the mode: HE GSM GPRS mode, Built in/ ETN Ethernet mode, or HE XEC Ethernet mode.</p> <p>Select <b>HE GSM GPRS mode</b> if communication with RCC series controller on GPRS is required and the device has GSM modem installed in RCC series controller.</p> <p>Select <b>Built in/ ETN Ethernet mode</b> if the device has on-board Ethernet port.</p> <p>Select <b>HE XEC Ethernet mode</b> if the device has Ethernet comm. option board installed in RCC series controller.</p> <p><b>NOTE:</b> For GPRS connectivity, GPRS configuration from <b>Programs → Messaging → GPRS</b> needs to be done.</p> <p><b>NOTE:</b> The controller should support the type of connectivity selected and configured for Ethernet communication.</p>
<b>CAN Interface</b>	Select this option to communicate over CAN. This option requires additional hardware to be installed with the PC to be able to do so. Select the type of hardware installed from the dropdown.
<b>Installed Modem</b>	<p>Select this option to communicate to the device through the internal modem of the computer. Cscape will automatically detect the internal modem attached with PC and list in the attached drop down. User can select modem and telephone number for target controller.</p> <p><b>NOTE:</b> Cscape will do necessary initialization for the selected internal modem.</p>
<b>USB</b>	Select this option to communicate over USB. Now Horner devices and Horner USB to serial converters are recognized and can be specifically selected.
<b>Connected Device</b>	
<b>NOTE:</b> This configuration is required if the controller to which Cscape is communicating is connected to a CsCAN network.	
<b>Connected Device</b>	By default, this option is selected and networking feature of Cscape is disabled.
<b>Target Node ID</b>	On selecting this option, Networking feature of Cscape is enabled. CsCAN ID for the target controller to be provide here.
<b>Connection Settings (General Communication Settings)</b>	
<b>Maximum Baud Rate</b>	Select the baud rate for serial communication.
<b>Timeout</b>	<p>Select the communication timeout.</p> <p><b>NOTE:</b> Select a larger timeout for GPRS and installed modem communication configuration</p>

If communications are successful, the message line should show “USB (COM8)” for this example, and an (R) should follow the Target number. For more information on the status bar, see the status section [above](#) in this chapter, section [Cscape Status Bar](#).



When connected directly to the controller to which Cscape communications are required, the **Local ID** and the **Target ID** should match.

Local ID and Target ID Match

If communication is established, the target indicator will show the mode of the controller **Target: yy(R)** as shown in the status section above in this chapter, section Cscape Status Bar.

If the controller is not communicating, ensure the target ID is set correctly. The **Target ID** allows directing communications to a particular unit when multiple units are connected via a CsCAN network. Units without CsCAN network ports respond to any network ID and do not require the ID to be configured.

To change the RCC target ID in Cscape, go to **Controller → Set Local Network ID**.

### 11.3.1 Communicating via MJ1 Serial Port

Start by configuring Cscape to use the correct communications port. This can be done using the **Tools → Options → Communication Port** dialog in Cscape.

Connect the PC’s serial port to the port labeled MJ1 on the RCC.

If communications are successful, the target indicator should show the mode of the controller **Target: yy(R)** as shown in the status section above.

If the controller is not communicating, it may be required to set the target ID of the controller in Cscape.

The Target ID allows directing communications to a particular unit when multiple units are connected via a CsCAN network. Units without CsCAN network ports respond to any network ID and do not require the ID to be configured.

To change the Target ID of Cscape use the **Controller → Set Target Network ID** dialog.



### 11.3.2 Communicating via On Board Ethernet Port

From the factory, the RCC OCS is set to the IP Address 192.168.254.128. To obtain Ethernet communications between Cscape and the RCC OCS using a single Ethernet cable between a PC and the RCC, or through an unmanaged Ethernet Switch, the PC will also need to be manually configured as follows (may require Administrator access on PC):

1. Access the Network Connections in the Control Panel (Shortcut: Press the Windows key  and type 'Network Connections'... select the resulting filtered link).
  2. Double-click the connection being used to directly connect to the RCC to bring up the Connection Status.
  3. Click **Properties**.
  4. Double-click **Internet Protocol Version 4 (TCP/IPv4)** in the list of available protocols.
  5. The PC may normally be set to "Obtain an IP address automatically". Click next to **Use the following IP address**:
  6. Use the IP address 192.168.254.111 or something other than that of the RCC.
  7. The Subnet Mask (255.255.255.0) should fill in automatically once the IP address has been entered.
  8. The Default Gateway is not required for a direct connection.
  9. Click OK all the way back to the Network Connections dialog.
  10. Confirm the RCC is set to the default 192.168.254.128 address or something on the same network.
  11. In Cscape, click **Tools → Application Settings → Communications → Configure .**
  12. Select Ethernet, and then enter the IP address of the RCC.
- NOTE:** The MTU setting defaults to the maximum 1500. It needs to match the PC's MTU setting for the best results. A PC may be set to an MTU of 1300 or something other than the default maximum setting by a network administrator.
13. The **Port** for CsCAN over Ethernet is **18501**.
  14. The **Mode** for any controller with built-in Ethernet is **Built-in/ETN Ethernet Mode**.
  15. Change the **Timeout** value to **3000** for direct connections. Timeout values of 5000-30000+ may be common for access over the internet or via VPN or other more complex networks.
  16. Click **OK** all the way back to the main Cscape window. It may take a moment to initialize the communications.
  17. Check the status bar for successful communications.

ETN : 172.27.1.183	User: NONE	HERCC Model Equal	Equal	Local:253 Target:253(R) [no forces]	MOD
--------------------	------------	-------------------	-------	-------------------------------------	-----

See the next page for examples of the PC Ethernet setup and the Cscape Ethernet setup mentioned in the above steps.

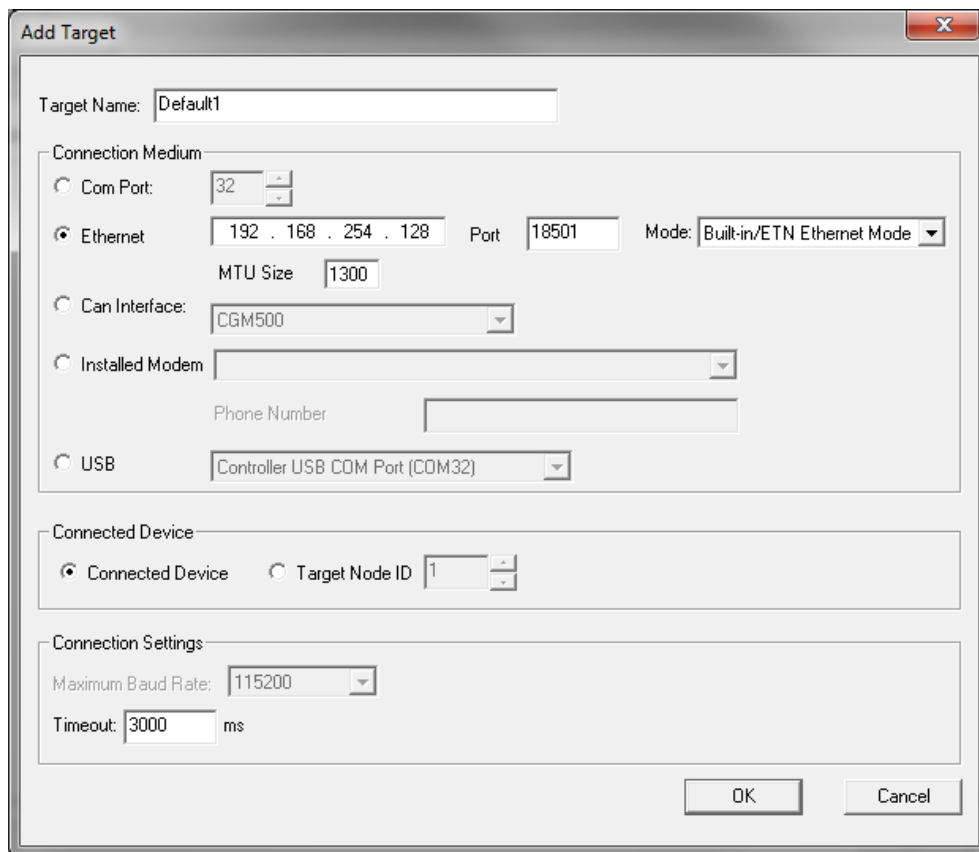
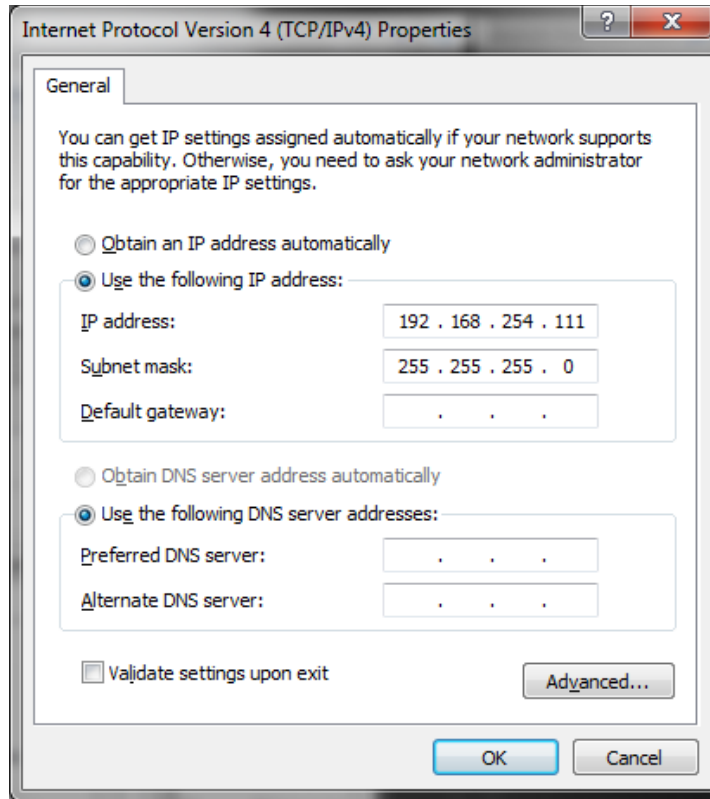

To configure the Ethernet settings of the RCC using Cscope, go to **Controller → Hardware Configuration**. If not already done, select the correct connected controller, or use the **Auto Config** button to automatically recognize a controller that is already successfully connected to Cscope.

Below the main controller configuration, under **Network Ports**, find **LAN1** and click on the **Config** button to the right of the greyed-out ETN300.

In the LAN1 Configuration, fill in the network setup for the RCC. It may be required to consult IT personnel to determine proper settings if connection to a corporate network is needed.

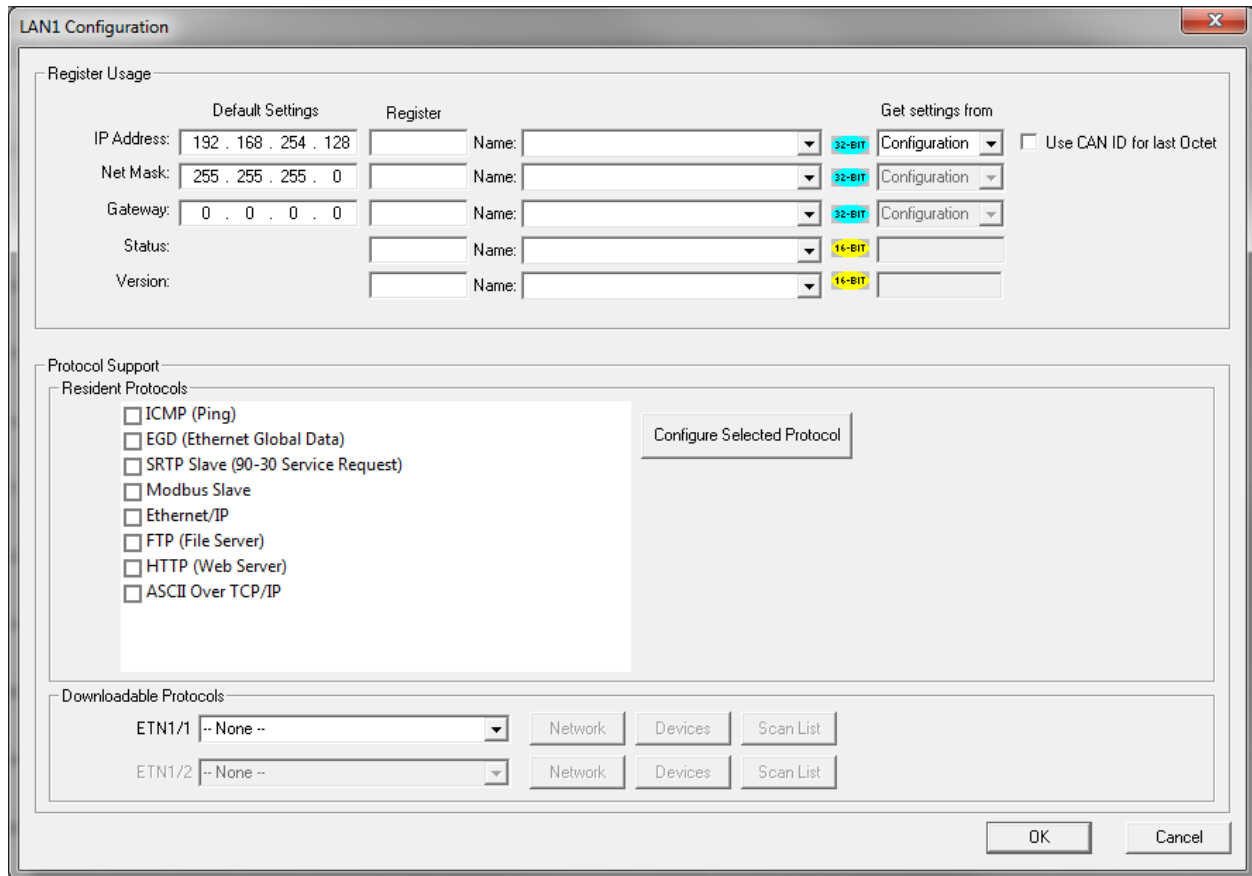

Register Usage		Get settings from	
Default Settings	Register		
IP Address: 192 . 168 . 254 . 128	<input type="text"/>	Name: <input type="text"/>	32-BIT Configuration
Net Mask: 255 . 255 . 255 . 0	<input type="text"/>	Name: <input type="text"/>	32-BIT Configuration
Gateway: 0 . 0 . 0 . 0	<input type="text"/>	Name: <input type="text"/>	32-BIT Configuration
Status:	<input type="text"/>	Name: <input type="text"/>	16-BIT
Version:	<input type="text"/>	Name: <input type="text"/>	16-BIT

**Protocol Support**

**Resident Protocols**

- ICMP (Ping)
- EGD (Ethernet Global Data)
- SRTP Slave (90-30 Service Request)
- Modbus Slave
- Ethernet/IP
- FTP (File Server)
- HTTP (Web Server)
- ASCII Over TCP/IP

**Downloadable Protocols**

ETN1/1	-- None --	Network	Devices	Scan List
ETN1/2	-- None --	Network	Devices	Scan List

If **Get settings from** is set to **Configuration** for any parameter, the addresses in the **Default Settings** column will take place when this program is loaded and every time this controller enters RUN mode. Registers may optionally be defined that will reflect the settings.

If **Get settings from** is set to **Register** for any parameter, the addresses in the **Default Settings** column are ignored entirely. The addresses instead must come from the configured registers.

## 11.4 Hardware Configuration

An overview of configuration:

1. Start the configuration by selecting the **Controller** → **Hardware Configuration** menu item.
2. If the RCC is already connected and communicating with Cscope, press the **Auto Config System** button to automatically detect the connected RCC model.
3. If the RCC is not connected:
  - a. Select **RCC Series** from the Series dropdown.
  - b. Confirm **HERCC** in the Device Type dropdown.
  - c. Select the model to be used from the Model # dropdown.

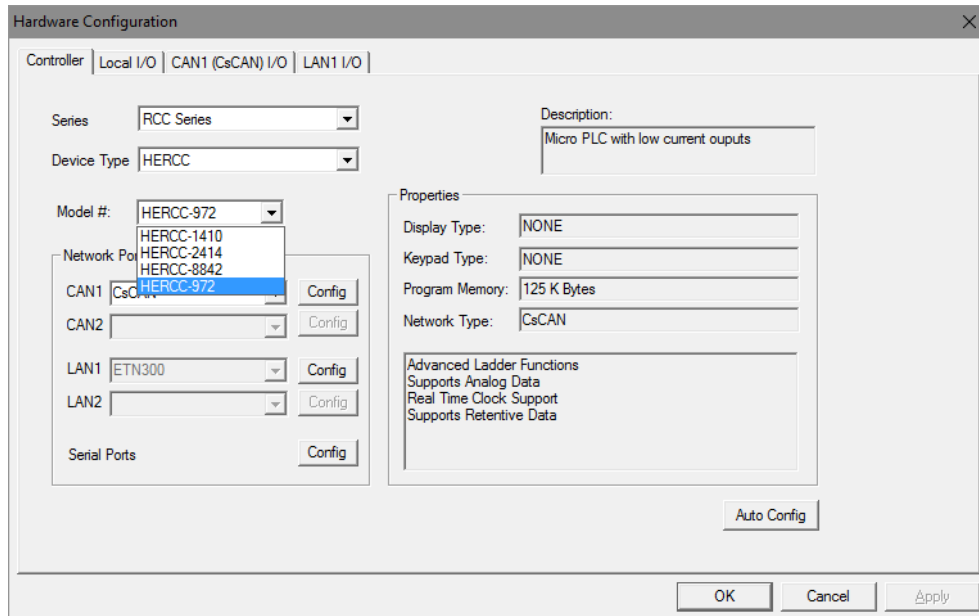

Hardware Configuration

Controller | Local I/O | CAN1 (CsCAN) I/O | LAN1 I/O

Series: RCC Series

Device Type: HERCC

Model #: HERCC-972

Network Port: CsCAN

CAN1: CsCAN

CAN2:

LAN1: ETN300

LAN2:

Serial Ports:

Description: Micro PLC with low current outputs

Properties

Display Type: NONE

Keypad Type: NONE

Program Memory: 125 K Bytes

Network Type: CsCAN

Advanced Ladder Functions

Supports Analog Data

Real Time Clock Support

Supports Retentive Data

Auto Config

OK Cancel Apply

- Click the **Local I/O** tab to access the configuration for the I/O.

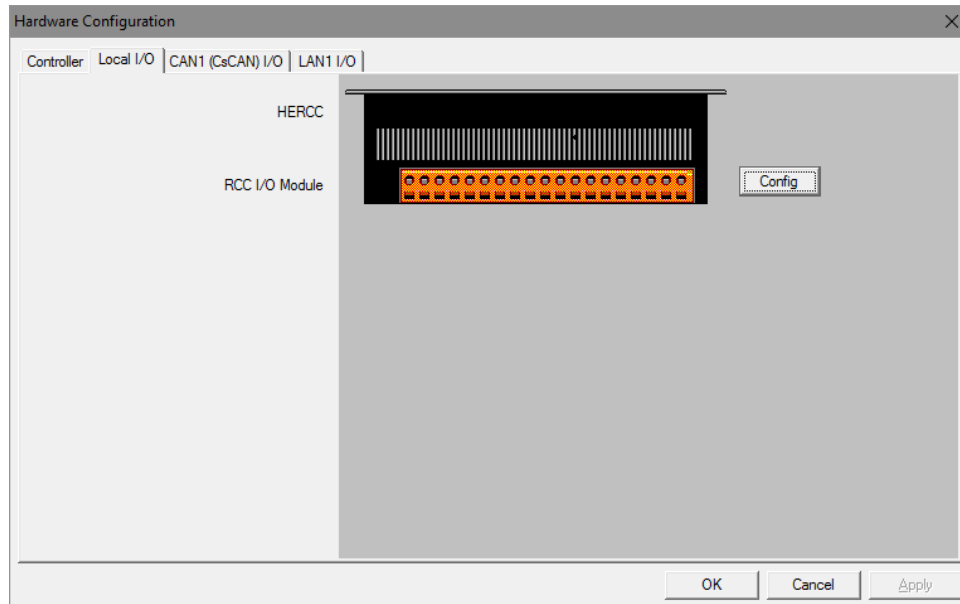

- From here, the I/O map and addresses may be viewed. These addresses may not be changed and no other program configurations, such as remote I/O, should overlap these addresses.
- Next, click the **RCCxxx Configuration** to configure I/O. Depending on the RCC model being used, some or all of the following options may be available

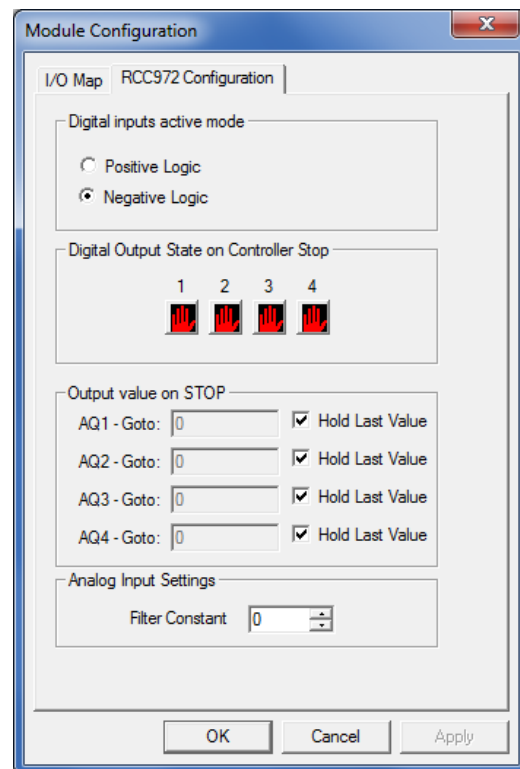
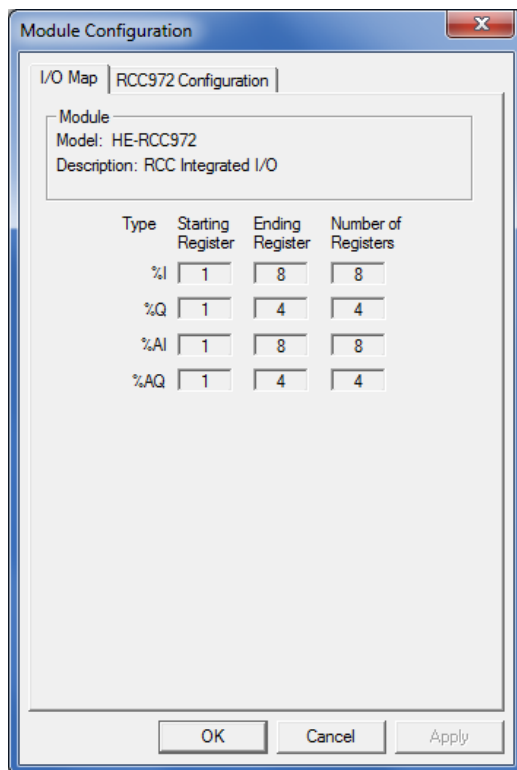

7. Configure the **Digital Inputs** to operate as required.
  - a. If **Positive Logic**, the inputs will register as 'ON' if voltage is applied to the input pin.
  - b. If **Negative Logic**, the inputs will register as 'ON' if the input pin is grounded.
8. Configure the **Digital Outputs** to be in the desired state when the RCC is put into STOP mode, such as when a program is being loaded.
  - a. By default, outputs will turn 'OFF'.
  - b. Outputs may be set to turn 'ON'.
  - c. Outputs may be set to 'Hold Last State'.
9. Configure the **Analog Inputs**.
  - a. The **Filter Constant** may be set from 0 to 7 to digitally filter the signal as shown in the following chart.
  - b. On some models, the input type may be specified as 4-20mA, 0-20mA, or 0-10V.
10. Configure the **Analog Outputs**.
  - a. The **Output Value on STOP** may be set to either 'Hold Last Value' or to a specific raw value from 0-32000 when the RCC is put into STOP mode, such as when a program is being loaded.
  - b. On some models, the Output Mode may be specified as 4-20mA, 0-20mA, or 0-10V.

For Analog Inputs, the **Filter Constant** sets the level of digital filtering according to the following chart. Digital filtering minimizes noise and jitter, improves effective resolution, and provides adequate speed for most temperature monitor control applications.

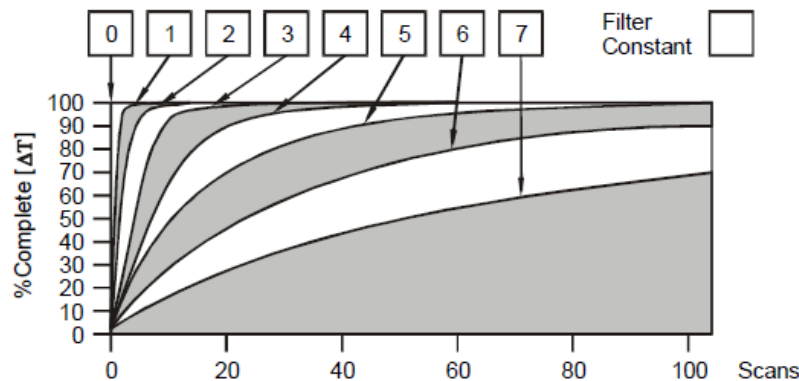

## 11.5 Scaling Analog Inputs

To access the Advanced Math Scaling function, select **Tools** → **Project Toolbox**. This will open a side bar, and then select **Advanced Math** → **Scale**.

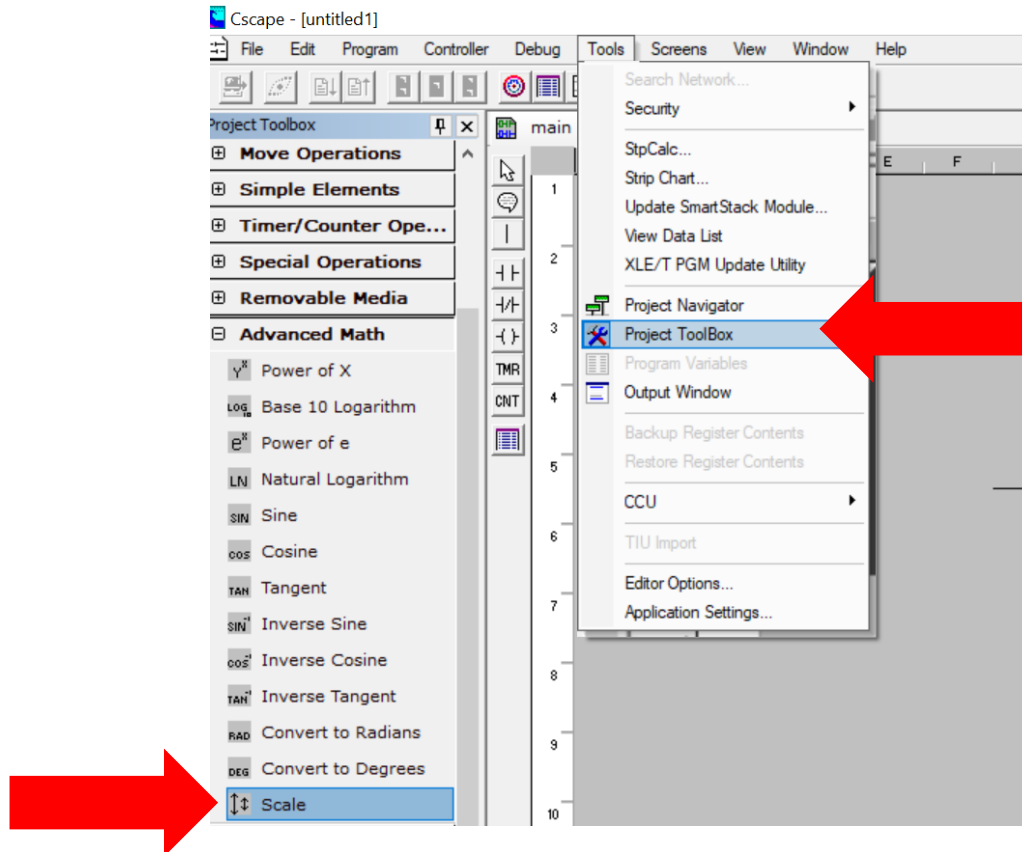

**Example 1**

The Cscape Scale function, found in the Advanced Math functions, allows for very easy conversion of the raw input value into a meaningful reading. For example, a pressure transducer may be specified as a 4-20mA signal to signify a 0-2000 psi pressure reading. With the analog channel set to the 4..20mA range, the raw analog input value, which is in INT format ranges from 0 to 4mA to 32000 for 20mA. Use the Scale function to obtain an Integer pressure reading using the 0-32000 raw input range and the sensor's 0-2000psi output range.

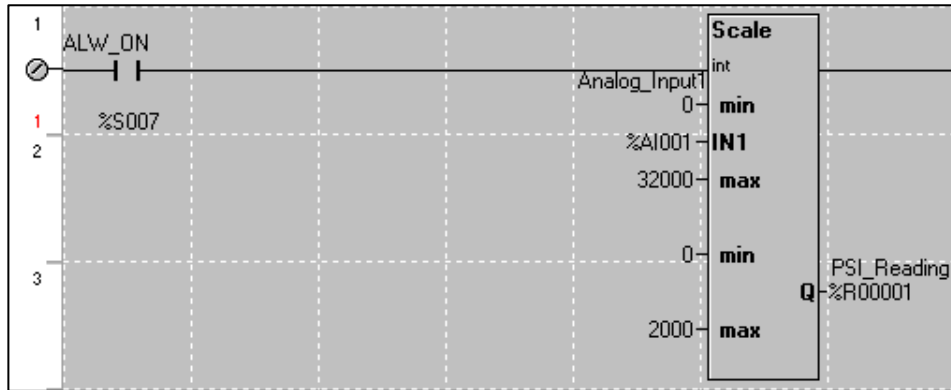

**Example 2:**

If readings with fractions are required, the raw Integer input value must first be translated in REAL, or Floating Point format. The Cscape INT-to-REAL Conversion function may be used to convert the raw input value from INT to REAL format in an intermediate memory location. The SCALE function, specified as REAL type, may be used to scale the converted raw value into a reading that supports digits beyond the decimal place, i.e. 475.25psi.

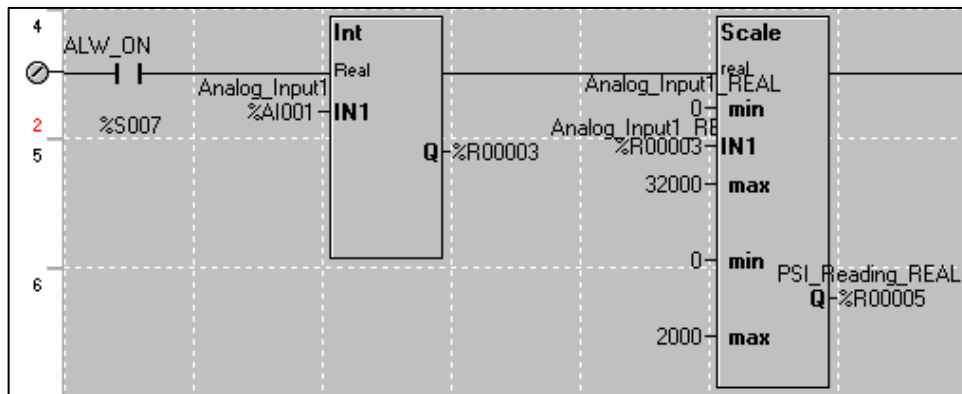



## CHAPTER 12: BACK-UP BATTERY

The following information pertains to RCC OCS units running 14.24 firmware and later.

The RCC972 does NOT have a back-up battery. The RCC1410, RCC2414, and RCC8842 use a 3.7 rechargeable lithium ion battery.

The controller will not charge the battery when it is outside. Its charging range is typically -10°C to 35°C.

**NOTE: For more details on the back-up battery, refer to the Battery Manual [MAN1142].**

### 12.1 Overview

The has an advanced battery system that uses a rechargeable lithium battery. The battery powers the real time clock when power is removed, and it is needed for register data retention.

### 12.2 Storing Register Contents

The OCS controllers with rechargeable batteries write register data to high speed RAM when connected to DC power. When this power is lost, critical circuits switch over and run on batter power for about 1/10 of a second. During this time, register and other retentive data is saved away to flash memory. The clock continues to run on the battery at a much lower power. The battery is designed to last well over a year in this state. Once power is restored, the battery recharges in eight (8) hours or less.

### 12.3 Battery Life

The battery is designed to last 300 full charges to 1000 partial charge cycles or 7 to 10 years. Because typical operation does not drain the battery, the 1000 charge cycles should never be reached and the 7 to 10-year aging of the battery would limit its useful life. The battery is designed to be replaced.

### 12.4 Lithium Battery Safety

Many of the publicized battery issues are a result of using multiple batteries of flexible battery packs. The OCS uses a small, single cell in a metal enclosure. The battery is UL recognized and comes from quality suppliers. The OCS has safety circuitry built into the charging IC and additional external protection including fusing. These circuits were closely evaluated by UL and Horner engineering for use in hazardous environments.

## 12.6 Battery Charging Status

Viewed in the System Menu under “View Battery Status”

<b>Waiting</b>	The charging system is waiting for voltages and temperatures to stabilize.
<b>Battery Charging</b>	The battery is charging.
<b>Battery Full</b>	Shows at the end of a charge cycle. Remains in this state until the battery is steadily discharging.
<b>Battery Discharging</b>	The battery is steadily discharging.

Table 12.1 - Charging State Table

## 12.7 Battery Charging State

In the RCC, the program downloaded from Cscope is not battery backed. The program is stored in flash memory RAM at the time of download. The battery plays no part in program retention.

## 12.8 Battery Status in System Registers

%SR195	Max CPU temperature
%SR196	Charge State 0 = Waiting 1 = Normal >1 = Special Condition
%SR197	Charging Current Max mA
%SR198	Battery Volt in mV

Table 12.2 - Battery Status

## CHAPTER 13: REGISTERS

### 13.1 Register Definitions

When programming the RCC, data is stored in memory that is segmented into different types. This memory in the controller is referred to as registers. Different groups of registers are defined as either bits or words (16 bits). Multiple registers can usually be used to handle larger storage requirements. For example, 16 single-bit registers can be used to store a word or two 16-bit registers can be used to store a 32-bit value.

Below is a table of the type of registers found in the RCC unit.

Table 13.1—Types of Registers	
Register	Description
%AI Analog Input	16-bit input registers used to gather analog input data such as voltages, temperatures, and speed settings coming from an attached device.
%AQ Analog Output	16-bit output registers used to send analog information such as voltages, levels, or speed settings to an attached device.
%AIG Global Analog Input	Specially defined 16-bit input registers that come from the network.
%AQG Global Analog Output	Specially defined 16-bit output registers that go to the network.
%D Display Bit*	These are digital flags used to control the displaying of screens on a unit which has the ability to display a screen. If the bit is SET, the screen is displayed.
%I Digital Input	Single-bit input registers. Typically, an external switch is connected to the registers.
%IG Global Digital Input	Specially defined single-bit inputs that come from the network.
%K Key Bit	Single-bit flags used to give the programmer direct access to any front panel keys appearing on a unit.
%M Retentive Bit	Retentive single-bit registers.
%Q Digital Output	Single-bit output registers. Typically, these bits are connected to an actuator, indicator light or other physical outputs.
%QG Global Digital Output	Specially defined single-bit outputs that go to the network.
%R General Purpose Register	Retentive 16-bit registers.
%S System Bit	Single-bit coils predefined for system use.
%SR System Register	16-bit registers predefined for system use.
%T Temporary Bit	Non-retentive single-bit registers.

\* Not supported by RCC Units.

## 13.2 Useful %S and %SR registers

Table 13.2- Common %S Register Definitions	
Register	Description
%S1	Indicate First Scan
%S2	Network is OK
%S3	10mS timebase
%S4	100mS timebase
%S5	1 second timebase
%S6	I/O is OK
%S7	Always ON
%S8	Always OFF
%S9	Pause 'n Load soon
%S10	Pause 'n Load done
%S11	I/O being forced
%S12	Forcing is enabled
%S13	Network I/O is OK
%S16	Ethernet COM module is OK

Table 14.3 - %SR Registers - Master %SR Table					
Register	Default I/O Name	Description	Min-Max Values	Program (Read/Write)	Display (Read/Write)
%SR1	USER_SCR	User Screen Number <b>*Excludes RCC Units</b>	0 to 1023	Read/Write	Read/Write
%SR2	ALRM_SCR	Alarm Screen Number (0=none) <b>*Excludes RCC Units</b>	0 to 1023	Read Only	Read Only
%SR3	SYS_SCR	System Screen Number 1 = Main System Menu 2 = Set Network ID, Network Status, (%SR29) 3 = Set Network Baud (%SR30) 4 = Set Contrast (%SR32) 5 = View OCS Status 6 = View OCS Diagnostics 7 = View I/O Slots 8 = Set Function Key Mode (%SR33) 9 = Set Serial Ports (%SR34) 10 = Set Time/Date (%SR44- %SR50) 11 = Set Beeper (%SR183) 12 = Set Screen (%SR185) 13 = Removable Media 14 = View Protocols 15 = IP Address (ETN I/O Board) 16 = Fail Safe System 17 = Backup / Restore Data 18 = Enable AutoRun 19 = Enable AutoLoad 20 = Clone Unit - 21 = Touch Calibration 24 = License Details <b>*Excludes RCC Units.</b>	0 to 24	Read/Write	Read/Write

Table 14.3 - %SR Registers - Master %SR Table

Register	Default I/O Name	Description	Min-Max Values	Program (Read/Write)	Display (Read/Write)
%SR4	SELF_TST	Self-Test Results		Read Only	Read Only
%SR4.1		Self-Test Results - BIOS Error		Read Only	Read Only
%SR4.2		Self-Test Results - Engine Error		Read Only	Read Only
%SR4.3		Self-Test Results - Ladder Error		Read Only	Read Only
%SR4.4		Self-Test Results - RAM Error		Read Only	Read Only
%SR4.5		Self-Test Results - Duplicate ID Error		Read Only	Read Only
%SR4.6		Self-Test Results - Bad ID Error		Read Only	Read Only
%SR4.7		Self-Test Results - I/O Configuration Error		Read Only	Read Only
%SR4.8		Self-Test Results - Bad Network Error		Read Only	Read Only
%SR4.9		Self-Test Results - Bad Logic Error		Read Only	Read Only
%SR4.10		Self-Test Results - Bad Clock Error		Read Only	Read Only
%SR4.11		Self-Test Results - DeviceNet Error		Read Only	Read Only
%SR4.12-.16	Reserved				
%SR5	CS_MODE	Control Station Mode 0= Idle 1= Do I/O 2= Run 3= Online Change <b>*Supported in Linux and XL+ units only</b>	0 to 3	Read Only	Read/Write
%SR6		Average Scan Rate ms ( / 10)		Read Only	Read Only
%SR7		Minimum Scan Rate ms ( / 10)		Read Only	Read Only
%SR8		Maximum Scan Rate ms ( / 10)		Read Only	Read Only
%SR9	TCH_PRESSURE	Current Touch Pressure	0 to 3000	Read Only	Read Only
%SR10	TCH_PRESSURE_TSH	Threshold Touch Pressure	0 to 3000	Read/Write	Read/Write
%SR11-12		Ladder Size (32-Bit DINT)		Read Only	Read Only
%SR13-14		User Text Screen Size (32-Bit DINT) <b>*Excludes RCC Units</b>		Read Only	Read Only
%SR15-16		System Text Screen Size (32-Bit DINT) <b>*Excludes RCC Units</b>		Read Only	Read Only
%SR17-18		I/O Configuration Table Size (32-Bit DINT)		Read Only	Read Only
%SR19-20		Network Config Table Size (32-Bit DINT)		Read Only	Read Only
%SR21-22		Security Data Table Size (32-Bit DINT)		Read Only	Read Only
%SR23		Ladder Code CRC		Read Only	Read Only
%SR24		User Text CRC		Read Only	Read Only
%SR25		System Text CRC		Read Only	Read Only
%SR26		I/O Configuration Table CRC		Read Only	Read Only
%SR27		Network Configuration Table CRC		Read Only	Read Only
%SR28		Security Data Table CRC		Read Only	Read Only

**Table 14.3 - %SR Registers - Master %SR Table**

Register	Default I/O Name	Description	Min-Max Values	Program (Read/Write)	Display (Read/Write)
%SR29	NET_ID	<b>Network ID</b>		Read Only	Read / Write
		CsCAN Mode	1 to 253		
		DeviceNet Mode	0 to 63		
		CANOpen Mode	1 to 127		
%SR30		Network Baud Rate 0=125KB 1= 250kB 2= 5000KB 3= 1MB 4=50K	0 to 4	Read Only	Read/Write
%SR31		Network Required 0= Network <u>not</u> required 1= Network required; 2= Network optimized; 3= Network required and optimized	0 to 3	Read Only	Read Only
%SR32		LCD Display Contrast setting <b>*Excludes RCC Units</b>	0 to 255	Read Only	Read/Write
%SR33		Function Key Toggle Mode 0= Momentary 1= Toggle <b>*Excludes RCC Units</b>	0 to 1	Read/Write	Read/Write
%SR34		RS232 Serial Protocol Mode 0= Firmware Update (RISM) 1= CsCAN 2= Generic (Ladder- Controlled) 3= Modbus RTU 4= Modbus ASCII		Read Only	Read Only
%SR35-36		Unique Serial Number / Hexadecimal LAN1 MAC ID.  		Read Only	Read Only
%SR37		Model Number		Read Only	Read Only
%SR38		Engine Version ( /100)		Read Only	Read Only
%SR39		BIOS Rev Number ( / 100)		Read Only	Read Only
%SR40		FPGA Image Rev Number ( / 10)		Read Only	Read Only
%SR41		Vertical Pixel Count <b>*Excludes RCC Units</b>		Read Only	Read Only
%SR42		Horizontal Pixel Count <b>*Excludes RCC Units</b>		Read Only	Read Only
%SR43		Keypad Type <b>*Excludes RCC Units</b>		Read Only	Read Only
%SR44	RTC_SEC	Real-Time-Clock Second	0 to 59	Read Only	Read Only
%SR45	RTC_MIN	Real-Time-Clock Minute	0 to 59	Read Only	Read Only
%SR46	RTC_HOUR	Real-Time-Clock Hour	0 to 23	Read Only	Read Only
%SR47	RTC_DATE	Real-Time-Clock Date	1 to 31	Read Only	Read Only
%SR48	RTC_MON	Real-Time-Clock Month	1 to 12	Read Only	Read Only
%SR49	RTC_YEAR	Real-Time-Clock Year	1996 to 2095	Read Only	Read Only

Table 14.3 - %SR Registers - Master %SR Table					
Register	Default I/O Name	Description	Min-Max Values	Program (Read/Write)	Display (Read/Write)
%SR50	RTC_DAY	Real-Time-Clock Day (1=Sunday)	1 to 7	Read Only	Read Only
%SR51		Network Error Count		Read Only	Read Only
%SR52		Watchdog-Tripped Error Count		Read Only	Read Only
%SR53-54	<b>Reserved</b>				
%SR55.13		Self-Test: Battery Low or Missing		Read Only	Read Only
%SR56	LAST_KEY	Key Currently Pressed No key = 0 (No key pressed since power-up) F1 = 1 F2 = 2 F3 = 3 F4 = 4 F5 = 5 F6 = 6 F7 = 7 F8 = 8 F9 = 9 F10 = 10 F11 = 11 F12 = 12 Enter = 13 +/- = 14 . (dot) = 15 0 = 16 1 = 17 2 = 18 3 = 19 4 = 20 5 = 21 6 = 22 7 = 23 8 = 24 9 = 25 System = 26 Escape = 27 Left = 28 Right = 29 Up = 30 Down = 31 Shift = 32 Soft Key 1 = 34 Soft Key 2 = 35 Soft Key 3 = 36 Soft Key 4 = 37 Soft Key 5 = 38 Soft Key 6 = 39 Soft Key 7 = 40 Soft Key 8 = 41 Release = 255 (Keys pressed since power-up but not currently) <b>*Excludes RCC Units</b>	0 to 255	Read Only	Read Only
%SR57		LCD Backlight Dimmer Register 0-100 = 0% to 100% On 100-255 = 100% On <b>*Excludes RCC Units</b>	0 to 255	Read/Write	Read/Write

**Table 14.3 - %SR Registers - Master %SR Table**

Register	Default I/O Name	Description	Min-Max Values	Program (Read/Write)	Display (Read/Write)
%57.16		Temporarily disable Screen Saver <b>*Excludes RCC Units</b>		Read/Write	Read/Write
%SR58	USER_LEDS	User LEDs		Read/Write	Read/Write
%SR59		Engine Build Number (Only last three numbers displayed)		Read Only	Read Only
%SR60		Build Option Build Test = 0 Build Beta = 1 Build Product = 2	0 to 2	Read Only	Read Only
%SR61	NUM_IDS	Number of CsCAN Network IDs		Read Only	Read Only
%SR62-100	<b>Reserved</b>				
%SR101.3		WebMI License Details - WebMI server status <b>*XLEe, XLTe, X2, X4, &amp; X7 only</b>		Read Only	Read Only
%SR101.4		WebMI License Details - WebMI user logged in status <b>*XLEe, XLTe, X2, X4, &amp; X7 only</b>		Read Only	Read Only
%SR101.8-101.16		WebMI License Details - Number of users <b>*XLEe, XLTe, X2, X4, &amp; X7 only</b>		Read Only	Read Only
%SR102-107	<b>Reserved</b>				
%SR108		WebMI License Details - Number of webpages <b>*XLEe, XLTe, X2, X4, &amp; X7 only</b>		Read Only	Read Only
%SR109		WebMI License Details - Number of datapoints <b>*XLEe, XLTe, X2, X4, &amp; X7 only</b>		Read Only	Read Only
%SR110-112		WebMI License Details - Expiry date of WebMI license <b>*XLEe, XLTe, X2, X4, &amp; X7 only</b>		Read Only	Read Only
%SR113-130	<b>Reserved</b>				
%SR131-135		OCS Model: ASCII, 10 characters -		Read Only	Read Only
%SR136		Communication Download Timeout		Read Only	Read Only
%SR137		Communication Idle Timeout		Read Only	Read Only
%SR138-148	<b>Reserved</b>				
%SR149-150		Free-running 10kHz count: 1 count = 0.1ms (32-Bit DINT)		Read Only	Read Only
%SR151	<b>Reserved</b>				
%SR152		RS-485 Termination		Read / Write	Read / Write
%SR152.1		MJ2 Termination Enable <b>*Excludes RCC972</b>		Read / Write	Read / Write
%SR152.2		MJ3 Termination Enable <b>*XL+ Only</b>  RS485 Termination Enable <b>* X4 &amp; X7 Only</b>		Read / Write	Read / Write

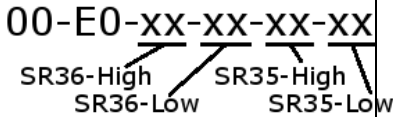

**Table 14.3 - %SR Registers - Master %SR Table**

Register	Default I/O Name	Description	Min-Max Values	Program (Read/Write)	Display (Read/Write)
%SR152.3*		MJ1 Termination Enable <b>*XL+, XLE, XLT, RCC2414 Only</b>		Read / Write	Read / Write
%SR152.4*		MJ1 Biasing <b>*XL+ Only</b>  CAN Termination Enable <b>*X4 &amp; X7 Only</b>		Read / Write	Read / Write
%SR153-163	Reserved				
%SR164		FailSafe / Clone			
%SR164.1		RS485 Port Biasing #1 (MJ1 or MJ2)		Read / Write	Read / Write
%SR164.2		RS485 Port Biasing #2 (MJ2 or MJ3)		Read / Write	Read / Write
%SR164.3	AUTO_RESTR D	Indicates Automatic Restore Operation has been performed		Read Only	Read Only
%SR164.4	BCKUP_TAKN	Indicates Backup of Registers has been taken		Read Only	Read Only
%SR164.5	EN_AUTO_RN	Enable AUTORUN - Sets "Enable AutoRun" to "Yes" or "No"		Read / Write	Read / Write
%SR164.6	EN_AUTO_LD	Enable AUTOLOAD - Sets "Enable AutoLoad" to "Yes" or "Not"		Read / Write	Read / Write
%SR164.7	STRT_BCKUP	Start Backup trigger bit - Setting TRUE starts backup of all register data		Read / Write	Read / Write
%SR164.8	CLR_BACKUP	Clear Backup trigger bit - Setting TRUE clears backup of all register data (if a backup was done previously)		Read / Write	Read / Write
%SR164.9	MAKE_CLON E	MAKE_CLONE trigger bit = Setting TRUE does a Load Clone (if a media card is present)		Read / Write	Read / Write
%SR164.10	LOAD_CLONE	LOAD_CLONE trigger bit - Setting TRUE does a LOAD CLONE (if a media card is present that contains clone files)		Read / Write	Read / Write
%SR164.11	MK_CLN_FL	Make Clone Fail (This bit goes high when Make/Create Clone fails)		Read / Write	Read / Write
%SR164.12	LD_CLN_FL	Load Clone Fail (This big goes high when Load Clone fails)		Read / Write	Read / Write
%SR164.14		Set to 1 to restore data manually, and this in turn sets %SR164.15 to 1. Set to 0 to abort restore operation. <b>*RCC Units Only</b>		Read / Write	Read / Write
%SR164.15		Set to 1 for manual restore of data. Set to 0 to complete the restore operation.		Read / Write	Read / Write

Table 14.3 - %SR Registers - Master %SR Table

Register	Default I/O Name	Description	Min-Max Values	Program (Read/Write)	Display (Read/Write)
		<b>*RCC Units Only</b>			
%SR165-166	Reserved				
%SR167		Screen Update Time, Default= 5 <b>*X4 &amp; X7 Only</b> - Default = 10	2 to 50	Read/Write	Read/Write
%SR168-170	Reserved				
%SR171		X-Coordinate Touched		Read Only	Read Only
%SR172		Y-Coordinate Touched		Read Only	Read Only
%SR173		System-Function Disable,	0 to 1	Read / Write	Read / Write
%SR174		Removable Media Protect		Read/Write	Read/Write
%SR174.1		Request Media Card be Removed		Read / Write	Read / Write
%SR174.2		Indicates safe to remove Media		Read / Write	Read / Write
%SR175		Removable Media - Status		Read Only	Read Only
%SR176-177		Removable Media Free Space (32-Bit DINT)		Read Only	Read Only
%SR178-179		Removable Media Total Space (32-Bit DINT)		Read Only	Read Only
%SR180	Reserved				
%SR181	ALM_UNACK	Bits 1-16 indicate Unacknowledged in Alarm Groups 1-16		Read Only	Read Only
%SR182	ALM_ACT	Bits 1-16 indicate Active in Alarm Groups 1-16		Read Only	Read Only
%SR183	SYS_BEEP	Beep on Keypress Enable 0= Disabled 1= Enabled	0 to 1	Read / Write	Read / Write
%SR184	USER_BEEP	Internal Beeper 0=OFF 1=ON	0 to 1	Read/Write	Read/Write
%SR185		Screen Saver Enabled 0= Disabled 1= Enabled <b>NOTE: See %SR57.16</b>	0 to 1	Read Only	Read Only
%SR186		Screen Saver Time in minutes (delay)	5 to 1200	Read Only	Read Only
%SR187	NET_USE	Network Usage (Avg)	0 to 1000	Read Only	Read Only
%SR188		Network Usage (Min)	0 to 1000	Read Only	Read Only
%SR189		Maximum Net Usage of all units on the CAN network	0 to 1000	Read Only	Read Only
%SR190	NT_TX_AVG	Network TX Usage % ( / 10) (Avg)	0 to 1000	Read Only	Read Only
%SR191		Network TX Usage % ( / 10) (Min)	0 to 1000	Read Only	Read Only
%SR192		Network TX Usage % ( / 10) (Max)	0 to 1000	Read Only	Read Only
<b>EXTENDED SYSTEM REGISTERS</b>					
%SR193	ONLINE_CHG	Online Change			
%SR193.1		TRUE if 2 programs in target FLASH		Read Only	Read Only
%SR193.2		TRUE to switch programs, FALSE when complete		Read Only	Read Only
%SR193.3		TRUE if executing program is temporary test		Read Only	Read Only
%SR193.4		TRUE during last scan of switched-from program		Read Only	Read Only

Table 14.3 - %SR Registers - Master %SR Table

Register	Default I/O Name	Description	Min-Max Values	Program (Read/Write)	Display (Read/Write)
%SR193.5		TRUE during first scan of switched-to program		Read Only	Read Only
%SR193.6		TRUE to revert to FLASH and delete all RAM; FALSE when complete		Read Only	Read Only
%SR193.9		TRUE if error in temporary program		Read Only	Read Only
%SR194		Battery Charge Temp Low <b>*XL+ Only</b> - Frequency in MHz		Read Only	Read Only
%SR195		Battery Charge Temp High <b>*XL+ Only</b> - in degree centigrade		Read Only	Read Only
%SR196		Charging State  <b>NOTE:</b> Refer to MAN1142 for more details on Rechargeable Batteries  0=Waiting 1=Normal Charging 2=Hot Charge 3=Hot Charge 4= Battery Hot 5= Cold Charge 6=Battery Cold 7=No Battery 8= Not Charging (after 8 hours of charging) 9= CPU Hot, not charging 10 Battery voltage <2V, not charging 11= First 2 minutes Init Wait (Not Charging)	0 to 11	Read Only	Read Only
%SR197		Charging Current Max mA		Read Only	Read Only
%SR198		Battery Voltage is mV		Read Only	Read Only
%SR199	<b>Reserved</b>				
%SR200		InitRD Version ( /100)		Read Only	Read Only
%SR201-205		Linux Kernel version: ASCII, 10 characters		Read Only	Read Only
%SR206-208	<b>Reserved</b>				
%SR209.3		WebMI Server Status. Bit 3 is ON if server running.		Read Only	Read Only
%SR209.4		WebMI User Logged in Status. Bit 4 is ON if 1 or more users logged in.		Read Only	Read Only
%SR209.8-209.16		Number of Users. Shows in upper byte in decimal format.		Read Only	Read Only
%SR210		Time Zone: set in minutes + / - UTC. (Ex: EST is -4 hours = -240 minutes)		Read/Write	Read/Write
%SR211		Daylight Saving: YES = 1 Daylight Saving: NO = 0 (If daylight saving is enabled, one hour will be added to the local time).		Read/Write	Read/Write
%SR212		UTC - Seconds		Read Only	Read Only
%SR213		UTC - Minutes		Read Only	Read Only

Table 14.3 - %SR Registers - Master %SR Table					
Register	Default I/O Name	Description	Min-Max Values	Program (Read/Write)	Display (Read/Write)
%SR214		UTC - Hours		Read Only	Read Only
%SR215		UTC - Date		Read Only	Read Only
%SR216		UTC - Month		Read Only	Read Only
%SR217		UTC - Year		Read Only	Read Only
%SR218		Number of Webpages, license detail (XLE/XLT, X2, X4, & X7 use %SR101 & %SR108-112 for WebMI License Details.)		Read Only	Read Only
%SR219		Number of Data Points, license detail. (XLE/XLT, X2, X4, & X7 use %SR101 & %SR108-112 for WebMI License Details)		Read Only	Read Only
%SR220-222		Expiration Date of WebMI License, license detail. (XLE/XLT, X2, X4, & X7 use %SR101 & %SR108-112 for WebMI License Details)		Read Only	Read Only

For additional information on system bits and registers, refer to the Cscape Help file.

### 13.3 Resource Limits

Table 13.4 - Resource Limits	
Resource	Value
%S	13
%SR	192, 200-205
%T	2048
%M	2048
%R	4096
%K	5
%D	1023
%I	2048
%Q	2048
%AI	512
%AQ	512
%IG	64 (per ID)
%QG	64 (per ID)
%AIG	32 (per ID)
%AQG	32 (per ID)
Ethernet	CsCAN, Ping, EGD, SRTP, Modbus TCP Master (Downloadable protocol) & Slave, Ethernet IP, FTP, or HTTP @ 10MBd or 100MBd
CsCAN	125kBd, 250kBd, 500kBd, or 1MBd
Serial Ports	2 RS-232 / RS-485 Ports. Software Selectable.
IDs Per CsCAN Network	64 w/o repeat (253 w/ 3 repeaters)
Ladder Code	128kB

### 13.4 Register Map for RCC Series

Table 13.5–RCC Series Register Map			
RCC Model	REGISTER	DESCRIPTION	TYPE
RCC972	%I1 to %I8	Digital Inputs	
	%I9 to %I15	Reserved	
	%I16	%Q Fault Status	
	%Q1 to %Q4	Digital Outputs	
	%AI1 to %AI8	Analog Inputs	0-20mA
	%AQ1 to %AQ4	Analog Outputs	0-20mA
RCC1410	%I1 to %I14	Digital Inputs	
	%I15	Reserved	
	%I16	%Q Fault Status	
	%Q1 to %Q10	Digital Outputs	
RCC2414	%I1 to %I2	Digital Inputs	
	%I3 to %I15	Reserved	
	%Q1 to %Q4	Digital Outputs	
	%AI1	Analog Inputs	0-10VDC
	%AQ1 to %AQ4	Analog Outputs	0-10VDC
RCC8842	%I1 to %I8	Digital Inputs	
	%I9 to %I15	Reserved	
	%I16	%Q Fault Status	
	%Q1 to %Q8	Digital Outputs	
	%AI1 to %AI4	Analog Inputs	0-10VDC 0-20mA 4-20mA
	%AQ1 to %AQ2	Analog Outputs	0-10VDC 0-20mA 4-20mA

## CHAPTER 14: FAIL-SAFE SYSTEM

### 14.1 Overview

The Fail-Safe System is a set of features that allow an application to continue running in the event of certain types of "soft" failures. These "soft" failures include:

- Battery power loss
- Battery-Backed Register RAM or Application flash corruption due to, for example, an excessive EMI event.

The Fail-Safe System has the following capabilities:

- Manually backup the current battery-backed RAM Register Settings into flash memory.
- Manually restore Register Settings from the values previously backed up in flash memory to battery-backed RAM.
- Detect corrupted Register Settings at power-up and then automatically restore them from flash.
- Detect corrupted or empty application in flash memory at power-up and then automatically load the AUTOLOAD.PGM application file from Removable Media (Compact flash or microSD).
- If an automatic Register Restore or Application Load occurs, the OCS can automatically be placed in RUN mode.

### 14.2 Settings

To use the Fail-Safe feature, the user needs to do the following:

1. From Cscope, create AUTOLOAD.PGM for the application program using 'Export to Removable Media'.
2. Place the Removable Media with AUTOLOAD.PGM in the device.
3. Set the 'Enable AutoLoad' option in the device to YES.
4. Set the 'Enable AutoRun' option to YES if the controller needs to be placed in RUN mode automatically after automatic restore of data or AutoLoad operation.
5. Backup the current battery-backed RAM Register contents in onboard flash memory.

## 14.3 Backup / Restore Data

### Backup OCS Data:

When initiated, this will allow the user to manually copy battery-backed RAM contents on to the onboard flash memory of the OCS. This will have the effect of backing up all the registers and controller settings (Network ID, etc.) that would otherwise be lost due to a battery failure. %SR164.4 is set to 1 when backup operation is performed.

### Restore OCS Data:

When initiated, this will allow the user to manually copy the backed-up data from the onboard flash to the battery-backed RAM.

A restore operation will be automatically initiated if 1) a backup has been previously created and 2) on power-up the battery-backed RAM registers fail their check.

The following process will be followed for restoring data:

- The controller will be placed in IDLE mode.
- Data will be copied from onboard flash memory to OCS battery-backed RAM
- The controller will reset.
- The controller will be put in RUN mode if the AutoRun setting is 'Yes', or else it will remain in IDLE mode.

%SR164.3 is set to 1 when an automatic restore operation is performed. This bit is reset to the value of "0" when a new backup is created.

Restoring of data can be manually performed by setting %SR164.14 to 1, this in turn sets %SR164.15 to 1. The user needs to set %SR164.15 to 0 complete the restore operation or set %SR164.14 to 0 to abort.

### Clear Backup Data:

When initiated, the backup data will be erased from the onboard flash and no backup will exist. %SR164.4 and %SR164.3 is reset to 0 when backed up data is erased.



The OCS follows the following sequence in execution of Automatic Restore:

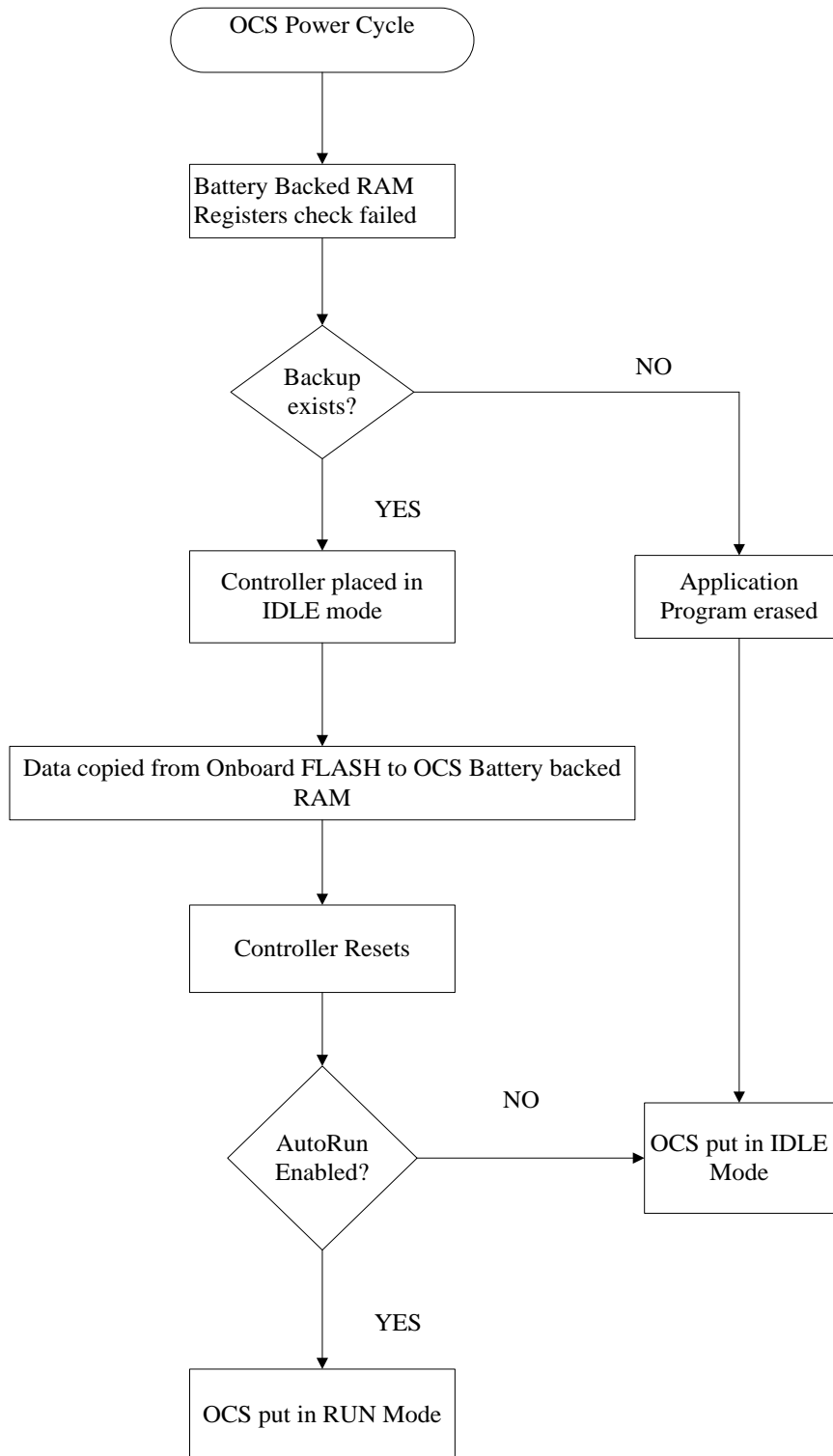

Figure 14.1 - Flow Chart for Automatic Restore

## 14.4 AutoLoad

This option allows the user to specify whether the OCS automatically loads the application AUTOLOAD.PGM located in Removable Media.

When the AutoLoad setting is enabled (set to YES), it can be automatically initiated at power-up.

The automatic initiation will happen only in the following two cases:

- When there is no application program in the OCS and a valid AUTOLOAD.PGM is available in the removable media of the device.
- When the program residing in onboard memory is corrupted and a valid AUTOLOAD.PGM is available in the removable media of the device.

When the AutoLoad setting is not enabled (set to NO), OCS will be in IDLE mode and the application is not loaded.

%SR164.6 can be set to enable AutoLoad feature.

The OCS follows the following sequence in execution of AutoLoad:

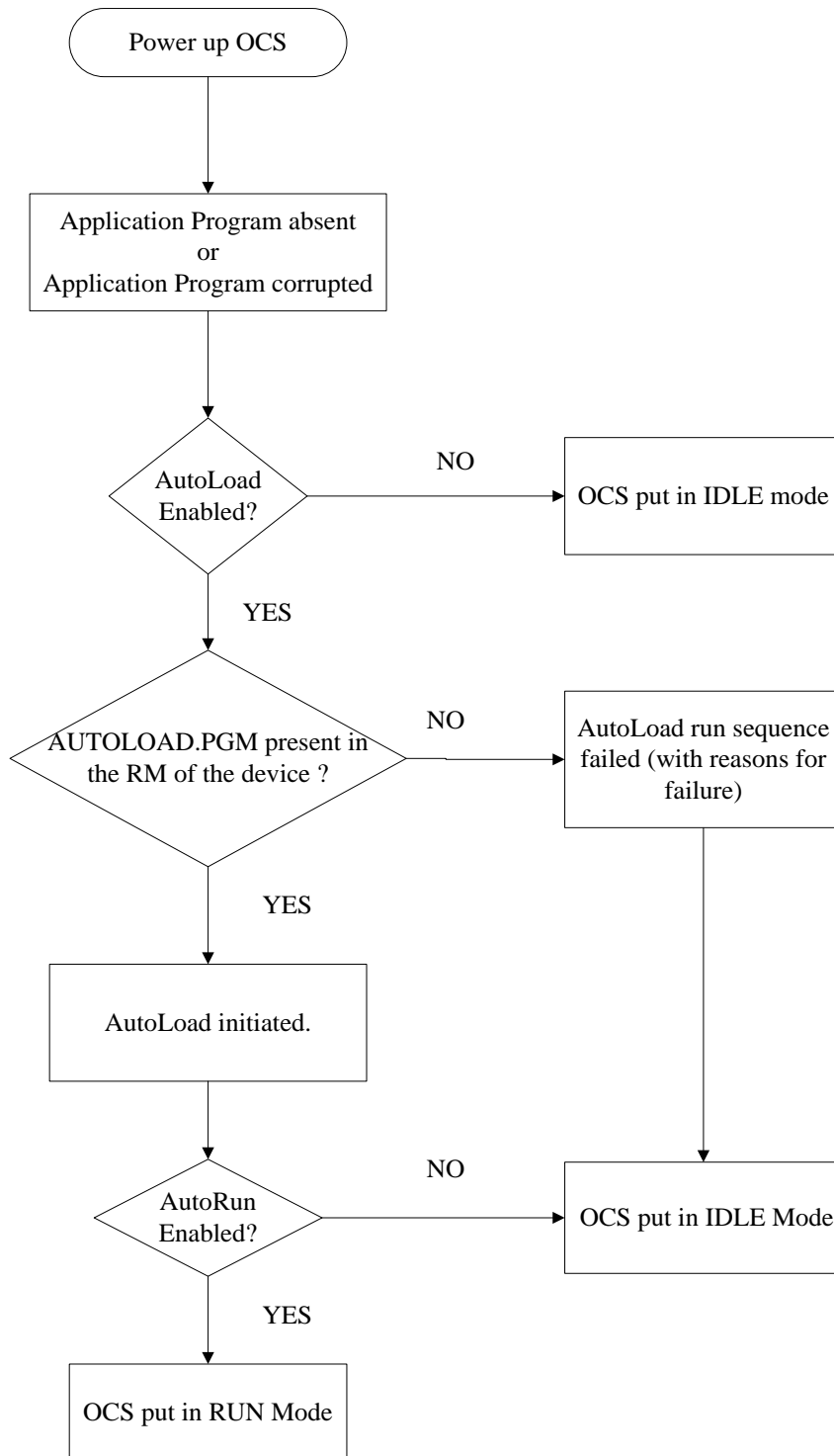

Figure 14.2 - Flow Chart for AutoLoad

## 14.5 AutoRun

This option, when enabled (YES), allows the user to automatically place the OCS into RUN mode after the AutoLoad operation or automatic Restore Data operation.

When the AutoRun setting is disabled (NO), the OCS remains in the IDLE mode after a Restore Data or AutoLoad operation.

%SR164.5 can be set for putting the system into RUN mode automatically, once an AutoLoad has been performed or an Automatic Restore has occurred.

## CHAPTER 15: MAINTENANCE

### 15.1 Firmware Updates

The RCC products contain field updatable firmware to allow new features to be added to the product at a later time. Firmware updates should only be performed when a new feature or correction is required. Updating the firmware erases the program memory and a program will need to be loaded into the RCC after the firmware update is finished for it to function again.

**WARNING:** Firmware updates should only be performed when the equipment being controlled by the RCC is in a safe, non-operational state. Communication or hardware failures during the firmware update process can cause the controller to behave erratically resulting in injury or equipment damage. Make sure the functions of the equipment work properly after a firmware update before returning the device to an operational mode.

#### Load switch

1. Pressing the **LOAD** switch during power-up boots from the microSD card. This starts a Firmware Load if the microSD is bootable and valid firmware files are found on it.
2. After boot-up, pressing the **LOAD** switch for three (3) seconds will load an Application file stored on the microSD. The application file name must be DEFAULT.PGM. When loading an application file from microSD, there should not be firmware files present on the microSD card.

**NOTE:** When pressing the LOAD switch for three seconds after boot-up, if firmware files present on the microSD card, it can trigger a firmware update that may not properly complete.

During the firmware update, the RUN and OK light will flash an alternating pattern. Once the firmware update is finished, load a program into the RCC and place in RUN mode.

### 15.2 Backup Battery

All the RCC OCS models, EXCEPT for the RCC972, use a lithium-ion battery. This battery powers the real time clock, registers, and data memory when power is removed. Under normal conditions, the battery should last seven years. Higher operating temperatures or variations in batteries may reduce this time.

**NOTE:** The battery is adhered to the unit and not replaceable.

**NOTE:** The RCC972 does not have a backup battery.

If the battery fails, please contact Horner Technical Support for further instructions. Do not attempt to disassemble the unit as the lithium battery may explode or catch fire if mishandled.

**WARNING:** Lithium batteries may explode or catch fire if mistreated. Do NOT recharge, disassemble, heat above 100°C (212°F), incinerate, or puncture.

## CHAPTER 16: MODBUS COMMUNICATIONS

### 16.1 Modbus Overview

For complete Modbus instructions, please refer to the Help file in Cscape.

Modbus (serial) and Modbus TCP/Modbus UDP (Ethernet) are popular, de-facto standard protocols that allow industrial devices from multiple manufacturers to easily share data in real-time. For Modbus serial communications, the RCC can act as either a Master or a Slave. For Modbus Ethernet communications, the RCC can act as either a Client (Master) or Server (Slave), or both at the same time.

Modbus protocol (serial or Ethernet) allows for one master and multiple slaves. The master always initiates the conversation by sending a request to a particular slave. Only the addressed slave will send a response when the request is completed. Should the slave be unable to complete the request, it returns the appropriate error response. Should the slave be unable to respond, the master's timeout timer expires to provide an indication of **No Response**.

### 16.2 Modbus Slave Overview

For complete Modbus Slave instructions, please refer to the Help file in Cscape.

The Modbus function block, when used with the appropriate Modem and /or Open function blocks, allows the primary serial port on the controller to act as a Modbus/RTU slave. The Modbus function supports both ASCII and RTU modes of operation across a range of baud rates and protocol frames. Also supported is port activity status, an inactivity timer, support for call-on exception, and support for store and forward (repeater) operation for radio modems.

For Modbus Server (slave) over Ethernet, the Modbus/TCP protocol simply needs to be selected in the LAN1 section of the Hardware Configuration dialog box in Cscape - see [Section 11.3.2](#). The RCC will automatically reply to Read and Write requests from a Modbus TCP Client (master).

Section 14.5 describes the supported Modbus Commands as well as the Modbus Map for RCC References (%R, %M, etc.). This map applies for both Modbus serial and Modbus over Ethernet.

## 16.3 Modbus Master Overview

For complete Modbus Master instructions, please refer to the Help file in Cscape.

When acting as a Modbus master, there are two primary mechanisms used by the RCC to allow the user to specify the data to be read/written from/to the slaves.

**Modbus Master Function Block**—For serial only. This is an advanced feature that should only be used in rare occasions.

**Protocol Config**—The Protocol Config is configured in the Hardware Configuration dialog box in Cscape (serial and Ethernet) - See [Section 11.3.2](#). This is the preferred method in most applications.

After the protocol has been selected from the dropdown menu, the **Network**, **Devices**, and **Scan List** become available. The Protocol Config is configured on three different levels:

- **Network**—Parameters, such as the polling rate of the data scan, are specified along with timeout values, retry, and re-acquisition settings. Serial configuration, baud rate, parity, etc. are also set here.
- **Devices**—For every slave to be polled, configuration details are added in the Devices dialog box. This includes Slave ID (serial) and IP Address (Ethernet). Under Device Type, the Modbus addressing style matching that specified in the slave's user documentation may be selected. For instance, some slaves specify Modbus addresses (i.e. 40,001), and others specify offsets (i.e. 0000).
  - **Hex or Decimal**—Some specify addresses in hex and others in decimal. By allowing the user to select the Modbus addressing style for each slave on the network, a minimum of address conversion is required. Also, if the slave is another Horner product (i.e. another RCC or an OCS), the "Native Addressing" option can be selected (i.e. %R1, %M17, etc.), and this skips the conversion to Modbus style altogether.
- **Scan List**—This is where the specific Modbus addresses to be read/written from/to each slave are specified. Up to 32 words of data can be read at the same time.
- **Ethernet Configuration**—Modbus TCP or Modbus UDP is selected here.

**NOTE:** Once configuration has been completed on the Network and Devices level, Modbus data can be directly read/written from graphics objects in the Cscape screen editor. This is available even if the Modbus register is not listed on the scan list.

The above information is just an introduction to the topic. For more detailed information, please consult the Cscape Help file.



## 16.4 Opening Cscape Help File

After opening the Cscape Help file, select the Index table and search for “Modbus Slave” or “Modbus Master”, as shown below.

Select “Index” tab.

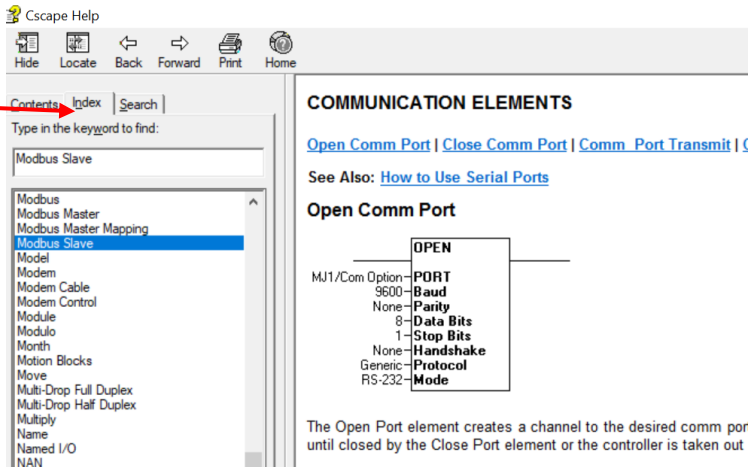

COMMUNICATION ELEMENTS

[Open Comm Port](#) | [Close Comm Port](#) | [Comm Port Transmit](#) | [Close Comm Port](#)

See Also: [How to Use Serial Ports](#)

**Open Comm Port**

	<b>OPEN</b>	
MJ1/Com Option:	<b>PORT</b>	
9600:	<b>Baud</b>	
None:	<b>Parity</b>	
8:	<b>Data Bits</b>	
1:	<b>Stop Bits</b>	
None:	<b>Handshake</b>	
Generic:	<b>Protocol</b>	
RS-232:	<b>Mode</b>	

The Open Port element creates a channel to the desired comm port until closed by the Close Port element or the controller is taken out

## 16.5 Modbus Addressing Table for RCC Units

To access RCC registers, a Modbus Master must be configured with the appropriate register type and offset. This is usually accomplished with one of two methods:

1. The first method uses **Traditional Modbus References**, in which the high digit represents the register type and the lower digits represent the register offset (starting with Register 1 for each type). Since only four register types can be represented in this manner, RCC Modbus Function Blocks pack several RCC register types into each Modbus register type. Starting addresses of each RCC register type are shown in the **Traditional Modbus Reference** column of the table.

2. The second method requires the Modbus Master to be configured with a specific **Modbus Command** and **Modbus Offset**. The supported Modbus commands and the associated offsets are also illustrated in Table 14.1.

**Table 16.1 - Modbus Master Mapping**

RCC Reference	Maximum Range	Trad. Modbus Ref (5 Digits)	Expanded Modbus Ref. (6 Digits)	Modbus Commands	Modbus Offset
%I1	2048	10001	010001	Read Input Status (2)	0
%IG1	64	13001	013001		3000
%S1	13	14001	014001		4000
%K1	0	15001	015001		5000
%Q1	2048	00001	000001	Read Coil Status (1) Force Coil (5) Force Multiple Coils (15)	0
%M1	2048	03001	003001		3000
%T1	2048	06001	006001		6000
%QG1	64	09001	009001		9000
%AI1	512	30001	030001	Read Input Register (4)	0
%AIG1	32	33001	033001		3000
%SR1	200	34001	034001		4000
%AQ1	512	40001	040001	Read Holding Register (3) Load Register (6) Load Multiple Registers (16)	0
%R1	2488	40513	040513		512
%R1	2048	43001	043001		3000
%AQG1	32	46001	046001		6000
%R1	4096	--	410001		10000

## CHAPTER 17: TROUBLESHOOTING / TECHNICAL SUPPORT

Chapter 17 provides commonly requested **troubleshooting information and checklists** for the following topics.

- Connecting to the RCC controller
- Local controller and local I/O
- CsCAN Network
- Removable media

If this information is not enough, please contact Technical Support at the locations indicated at the end of this chapter.

### 17.1 LED - Normal Functionality

Table 17.1 - LED: Normal Functionality				
LED Type	When OFF	When ON	When Flashing (1Hz)	When Toggling
PWR	No Power Applied	10-30VDC applied	N/A	N/A
OK	Self-Test Fail	Self-Test Pass	I/O Forcing Enabled	Application Loading from microSD
RUN	Stop Mode	Run Mode	Do I/O Mode	
LED	State	Description		
MS (Module Status)	Green	Module OK		
	Red	Real-Time Clock or I/O Configuration Error		
	White	Illegal Ladder Instruction or Ladder CRC Error		
NS (CAN Network Status)	Green	Network OK		
	Red	Illegal ID, Duplicate ID, or No Response from Network Error		

### 17.2 LED Load Program/Firmware Functionality

Table 17.2 - LED Load Program/ Firmware Functionality			
LED OK & RUN	Flashing Alternately	Flashing Together	Flashing Stops
Load program or firmware	Download in Progress	Download fails, number of flashes indicates the error.	Download Complete, unit reboots (allow 30 seconds).

### 17.3 Switch - Normal Functionality

**Load switch**

- Used for firmware updated, as noted in previous section

**Run/Stop switch**

- After boot-up, pressing the **RUN/STOP** switch for three (3) seconds toggles the RCC between RUN and STOP modes.

**Switch - Erase Program Function**

**Load and Run/Stop**

- After boot-up, pressing both Load and Run/Stop switches for three (3) seconds performs an "Erase All" function, which deletes all application programs.

### 17.4 LED - Diagnostic Functionality

The LEDs are also used to indicate some fault conditions in the unit. The two LEDs, OK and RUN, will flash a number of times depending upon the fault. There will be a two-second gap and the pattern will be repeated. The number of flashes and the associated error are as follows:

No. of flashes	Table 17.3 - Diagnostic LED Flashing/ Fault Meaning
2	The MAC ID is empty.
3	The internal MAC file is corrupt.
4	The MAC ID TXT file is invalid.
5	The MAC ID file is not found or the USD card is empty or missing system files.

## 17.5 Connecting to the RCC

Cscape connects to the local controller automatically when the serial connection is made. The status bar below shows an example of a successful connection. This status bar is located in the bottom right hand corner of the Cscape window.

Local:253 Target:253(R) [no forces]

In general, the **Target** number should match the **Local** number. The exception to this is when the controller is being used as a "pass through" unit where other controllers on a CsCAN network could be accessed through the local controller.

Determine connection status by examining feedback next to **Local & Target** in the status bar of Cscape.

Table 17.4 - Cscape Target & Local Numbers	
<b>Local: ###</b>	If a number shows next to <b>Local</b> , then communication is established to the local controller.
<b>Local: No Port</b>	Cscape is unable to access the COM port of the PC. This could mean that Cscape is configured for a COM port that is not present or that another program has control of the COM port. Only one Cscape window can access a port at a time. Subsequent instances of Cscape opened will indicate No Port.
<b>Local: No Com</b>	Cscape has accessed a PC COM port, but is not communicating with the controller. This typically occurs when the controller is not physically connected.
<b>Local: ???</b>	Unknown communication error. Close Cscape, power cycle the controller and reopen Cscape with a blank project. Check Local.
<b>Target: #(I,R,D)</b>	If I (idle), R (run), or D (do I/O) shows next to <b>Target number</b> , then communication is established to the target controller.
<b>Target: #(?)</b>	Communication is not established to the target controller. Check node ID of controller and set Target to match. Make sure <b>local</b> connection is established.

### ***17.5.1 Connecting Troubleshooting Checklist (serial port - MJ1 Programming)***

1. Controller must be powered up.
2. Ensure that the correct COM port is selected in Cscape. **Tools → Applications Settings → Communications.**
3. Ensure that a cable with proper pinout is being used between PC and controller port MJ1.
4. Check that a Loaded Protocol or ladder is not actively using MJ1.
5. Successful communications with USB-to-serial adapters vary. If in doubt, Horner APG offers a USB to serial adapter. Part numbers HE-XCK and HE-CPK.

### ***17.5.2 Connecting Troubleshooting Checklist (ETN port programming)***

1. Controller must be powered up.
2. Ensure that the correct IP address is given in the Ethernet field and correct Mode is selected, in Cscape: **Tools → Applications Settings → Communications Port.**
3. Ensure that an Ethernet connection has been established by pinging the controller from the Windows DOS prompt.

**WARNING: Setting outputs ON in Do I/O mode can result in injury or cause machinery to engage in an unsafe manner depending on the application and the environment.**

## 17.7 CsCAN Network

For complete information on setting up a CsCAN network, refer to CAN Networks manual (MAN0799) by visiting the Horner websites for the address to obtain documentation and updates.

### *17.7.1 CsCAN Network Troubleshooting Checklist*

1. Use the proper Belden wire type or equivalent for the network as specified in MAN0799.
2. The RCC does not provide 24VDC to the network. An external voltage source must be used for other devices such as SmartStix I/O.
3. Check voltage at both ends of the network to ensure that voltage meets specifications of attached devices.
4. Proper termination is required. Use 121 $\Omega$  (or 120 $\Omega$ ) resistors at each end of the network. The resistors should be placed across the CAN\_HI and CAN\_LO terminals.
5. Measure the resistance between CAN\_HI and CAN\_LO. If the network is properly wired and terminated there should be around 60 $\Omega$ .
6. Check for duplicate node ID's.
7. Keep proper wires together. One twisted pair is for V+ and V- and the other twisted pair is used for CAN\_HI and CAN\_LO.
8. Make sure the baud rate is the same for all controllers on the network.
9. Assure shields are connected at one end of each segment -- they are not continuous through the network.
10. Do not exceed the maximum length determined by the baud rate and cable type.
11. Total drop length for each drop should not exceed 6m (20'). A drop may include more than one node. The drop length adds to the overall network length.
12. Network should be wired in "straight line" fashion, not in a "star" pattern.
13. In applications requiring multiple power supplies, make sure the V- of all supplies is connected together and to earth ground at one place only.
14. In some electrically noisy environments it may be necessary to add repeaters to the network. Repeaters can be used to add additional nodes and/or distance to the network and protect the signal against noisy environments.

## 17.8 Removable Media - Basic Troubleshooting

Table 17.5 - Removable Media Troubleshooting	
Description	Action
RCC does not read media card.	Attempt to reformat microSD card on PC
RCC will not download project file.	Make sure the project file is saved as a .pgm file and not a .csp file. In addition, to file must be .pgm, the file's I/O configuration must match the RCC configuration for it to download.

## 17.9 Technical Support Contacts

For manual updates and assistance, contact Technical Support at the following locations:

### North America:

Tel: 1-877-665-5666

Fax: (317) 639-4279

Website: <https://hornerautomation.com>

Email: [techsppt@heapg.com](mailto:techsppt@heapg.com)

### Europe:

Tel: (+) 353-21-4321-266

Fax: (+353)-21-4321826

Website: [www.horner-apg.com](http://www.horner-apg.com)

Email: [technical.support@horner-apg.com](mailto:technical.support@horner-apg.com)



## MAIN INDEX

- %Q bits, 47
- 8.8-System Registers used with RM, 46
- Accessories, 14
- Analog Input Tranzorb - Troubleshooting, 49
- Analog Inputs, 49
- Analog Outputs, 49
- AutoLoad, 82
- Automatic Restore, 81
- AutoRun, 84
- Backup / Restore, 80
- Battery
  - Storing Register Contents, 65
- Battery Charging State, 66
- Battery Charging Status, 66
- Battery Life, 65
- CAN Comm
  - I/O Expansion (Network I/O), 27
  - Ladder-Controlled, 27
  - Overview, 24
  - Ports, 24
- CAN Communications, 24
- CAN Port Wiring, 25
- CE, 9
- Clear Backup Data, 80
- COM, 23, 27, 68, 93, 94
- COM port, 54, 93
- Common %S Register Definitions, 68
- Communicating via MJ1 Serial Port, 56
- Communicating via On Board Ethernet Port, 57
- Communication Configuration Dialog, 55
- Communications Port, 53, 54, 94
- Compliance
  - CE, 9
- Csape Program
  - Via Serial Port, 23
- Cscape, 13, 23, 24, 27, 44, 47, 48, 49, 50, 56, 76, 93, 94
  - Alternative Connection Method Screenshot, 54
  - Configuration Procedures, 60
  - Establishing Communications, 51
  - Overview, 50
  - Status Bar, 50
- CSCAPE CONFIGURATION, 50
- Cscape Connection Wizard Screenshots, 53
- Cscape Target & Local Numbers, 93
- Data Mapping
  - Update Type, 41
- Data Mapping Configuration, 41
- datasheet, 4, 47
- Default Gateway, 30
- Device Configuration, 39
- Device List, 38
- Device List and Device Configuration, 39
- Devices to Connect to RCC, 11
- Digital Inputs, 48
- Dimensions, 15
- Downloadable Communication Protocols, 33
  - Overview, 33
- ELECTRICAL INSTALLATION, 17
- Ethernet, 51, 68
- Ethernet Communication, 28
- Ethernet Configuration
  - IP Parameters, 32
- Ethernet Module
  - Default Gateway, 30
  - IP Address, 30
  - Net Mask, 30
  - Status Register, 30
  - Version Register, 31
- Ethernet Module Configuration, 29, 30
- Ethernet Module Protocol Configuration, 32
- Ethernet Module Protocols & Features**, 28
- Ethernet Module Protocols and Features, 28
- Ethernet Module Register Usage - Standard Configuration, 31
- Ethernet Module Specifications, 29
- Ethernet Status Word Register Format, 31
- Ethernet System Requirements, 28
- Fail Safe System Overview, 79
- Fail Safe System Settings, 79
- Features of RCC, 13
- Filename Special Symbols, 45
- Firmware Updates, 85
- fusing, 47
- General I/O
  - Overview, 47
- GENERAL I/O, 47
- Ground Specification, 17
- Grounding
  - Locations of Information, 9
- Grounding Definition, 17

- I/O Configuration Dialog, 29
- IP Address, 30
- LED – Diagnostic Functionality, 92
- LED Load Program/ Firmware Functionality, 91
- LED Normal Functionality, 91
- LIMITED WARRANTY, 3
- Lithium Battery Safety, 65
- Maintenance, 85
- Manual Index, 12
- Mechanical installation, 15
- microSD Cards, 43
  - Installing / Removing, 43
- microSD System, 43
- Modbus Addressing Table, 90
- Modbus Master, 88
- Modbus Master Mapping, 90
- Modbus Slave, 87
- Net Mask, 30
- Network Configuration, 36
- Opening Cscape Help File, 14, 89
- Overview
  - Battery, 65
  - Modbus, 87
- Panel Box
  - Noise, 16
  - Orientation, 16
  - Temperature, 16
- Panel Box Shock and Vibration, 16
- Polled Read, 41
- Polled Read/Write**, 41
- Polled Read/Write/Init**, 42
- Positive and Negative Inputs, 48
- Power Connector (Primary Power Port), 19
- Primary Power Port, 18
- Primary Power Port Pins**, 19
- PROGRAMMING EXAMPLES, 3
- Protocol Config, 35
- RCC Dimensions, 15
- RCC Manual PREFACE, 2
- RCC1410 MJ1 and MJ2 Pins, 21
- RCC2414 Pins, 22
- RCC972 MJ1 Pins, 21
- References / Useful documents, 14
- Register Map for RCC Series, 78
- register mapping, 47
- registers, 67
- Registers
  - Definitions, 67
  - Resource Limits, 77
- Removable Media
  - Load / Save Applications, 44
  - Log Data, 44
  - Overview, 43
  - Removable Media Troubleshooting, 96
  - Removable Media--Function Blocks in Cscape, 44
  - Removable Memory Card Slot Photograph, 43
- Resource Limits, 77
- RM Functional Blocks, 44
- RM Status Values, 46
- Safety Warnings, Guidelines, 8
- Scan List, 40
- Scan List Entry, 41
- Serial Comm
  - Cscape Programming, 23
  - Ladder-Controlled, 23
  - Overview, 20
- SERIAL COMMUNICATIONS, 20
- Solid-State Digital Outputs, 47
- sourcing, 47, 48
- stop state, 47
- Switch – Erase Program Function, 92
- Switch - Normal Functionality, 92
- target ID, 56
- Target ID**, 56
- target indicator, 56
- Technical Support**, 2, 91, 96
  - Contacts, 96
- Testing for Good Ground, 18
- Triggered Read**, 42
- Triggered Write**, 42
- Troubleshooting
  - Common problems, 93
  - Connecting Checklist, 94
  - CsCAN Checklist, 95
  - CsCAN Network, 95
  - Removable Media, 96
- TROUBLESHOOTING / TECHNICAL SUPPORT, 91
- Troubleshooting Checklist (Ethernet port Programming), 94
- Troubleshooting Checklist (serial port – MJ1) Programming, 94
- Two-Point Ground Connection Test, 18
- Types of Registers, 67
- USB, 27, 51, 52, 94
- Where to Find Information, 11



## INDEX OF FIGURES AND TABLES

Figure 2.2—Visual Overview of Types of devices that can be connected to RCC, 12
Figure 3.1 – RCC Dimensions, 15
Figure 4.1 – Two-Point Ground Connection Test, 18
Figure 4.2 – RCC972 Power Connector (Primary Power Port), 19
Figure 5.1 – RCC2414 Serial Port Pins, 22
Figure 6.1 – CAN Connection, 24
Figure 6.2 – RCC972 CAN Port Wiring, 25
Figure 6.3 – RCC1410 CAN Port Wiring, 25
Figure 6.4 – RCC2414 CAN Port Wiring, 26
Figure 6.5 – RCC8842 CAN Port Wiring, 26
Figure 7.1 – I/O Configuration Dialog, 29
Figure 7.2 – Ethernet Module Configuration, 30
Figure 8.1 – Protocol Config Dialog, 35
Figure 10.1 – Positive and Negative Inputs, 48
Figure 10.2 – Analog Input Tranzorb - Troubleshooting, 49
Figure 11. 1 - Cscape, 50
Figure 11. 2 –MJ1 Connector to be used via Serial or with Serial to USB adapter to PC, 51
Figure 11. 3 – Cscape Connection Wizard Screenshots, 53
Figure 11. 4 – Cscape Alternative Connection Method Screenshot, 54
Figure 11.5 – Add Target Screenshot in Cscape, 54
Figure 14.1 – Flow Chart for Automatic Restore, 81
Figure 14.2 – Flow Chart for AutoLoad, 83
Table 2.1 - Datasheets for RCC Models, 11
Table 4.1 – Primary Power Port Pins, 19
Table 5.1 - Datasheets for RCC Models, 20
Table 5.2 – RCC972 MJ1 Pins, 21
Table 5.3- RCC1410 MJ1 and MJ2 Pins, 21
Table 5.4 - RCC8842 MJ1 and MJ2 Pins, 22
<b>Table 7.1—Ethernet Module Protocols &amp; Features, 28</b>
Table 7.2 – Ethernet Module Specifications, 29
Table 7.3 - Ethernet Status Word Register Format, 31
<b>Table 8.1 - Network Protocols, 37</b>
Table 9.1 – RM Functional Blocks, 44
Table 9.2 – Filename Special Symbols, 45
Table 9.3 - RM System Registers, 46
Table 9.4 – RM Status Values, 46
Table 11.1—Communication Configuration Dialog, 55
Table 12.1 – Charging State Table, 66
Table 12.2 – Battery Status, 66
Table 13.1—Types of Registers, 67
Table 13.2– Common %S Register Definitions, 68
Table 13.4 – Resource Limits, 77
Table 13.5 - RCC Series Register Map, 78
Table 14.3 - %SR Registers, 68
Table 16.1 - Modbus Master Mapping, 90
Table 17.1 – LED Normal Functionality, 91

Table 17.2 – LED Load Program/Firmware Functionality, 91  
Table 17.3 – Diagnostic LED Flashing/ Fault Meaning, 92  
Table 17.4 – Cscape Target & Local Numbers, 93  
Table 17.5 – Removable Media Troubleshooting, 96